

# Modicon M258

## Logic Controller

## Hardware Guide

09/2020



EIO0000004159.00

[www.schneider-electric.com](http://www.schneider-electric.com)

**Schneider**  
Electric

---

The information provided in this documentation contains general descriptions and/or technical characteristics of the performance of the products contained herein. This documentation is not intended as a substitute for and is not to be used for determining suitability or reliability of these products for specific user applications. It is the duty of any such user or integrator to perform the appropriate and complete risk analysis, evaluation and testing of the products with respect to the relevant specific application or use thereof. Neither Schneider Electric nor any of its affiliates or subsidiaries shall be responsible or liable for misuse of the information contained herein. If you have any suggestions for improvements or amendments or have found errors in this publication, please notify us.

You agree not to reproduce, other than for your own personal, noncommercial use, all or part of this document on any medium whatsoever without permission of Schneider Electric, given in writing. You also agree not to establish any hypertext links to this document or its content. Schneider Electric does not grant any right or license for the personal and noncommercial use of the document or its content, except for a non-exclusive license to consult it on an "as is" basis, at your own risk. All other rights are reserved.

All pertinent state, regional, and local safety regulations must be observed when installing and using this product. For reasons of safety and to help ensure compliance with documented system data, only the manufacturer should perform repairs to components.

When devices are used for applications with technical safety requirements, the relevant instructions must be followed.

Failure to use Schneider Electric software or approved software with our hardware products may result in injury, harm, or improper operating results.

Failure to observe this information can result in injury or equipment damage.

© 2020 Schneider Electric. All rights reserved.

---

# Table of Contents

---



	<b>Safety Information</b> . . . . .	<b>5</b>
	<b>About the Book</b> . . . . .	<b>7</b>
<b>Chapter 1</b>	<b>TM5 System General Rules for Implementing</b> . . . . .	<b>13</b>
	Installation and Maintenance Requirements . . . . .	<b>14</b>
	Wiring Best Practices . . . . .	<b>17</b>
	TM5 Environmental Characteristics . . . . .	<b>23</b>
<b>Chapter 2</b>	<b>Modicon M258 Logic Controller Features</b> . . . . .	<b>27</b>
	About the Modicon M258 Logic Controller . . . . .	<b>28</b>
	Controller Description . . . . .	<b>30</b>
	Controller Common Characteristics . . . . .	<b>31</b>
	Real Time Clock (RTC) . . . . .	<b>34</b>
<b>Chapter 3</b>	<b>Modicon M258 Logic Controller Installation</b> . . . . .	<b>39</b>
	First Startup . . . . .	<b>39</b>
<b>Chapter 4</b>	<b>TM258LD42DT</b> . . . . .	<b>41</b>
	General Description . . . . .	<b>42</b>
	Characteristics of the Controller Power Distribution Module . . . . .	<b>46</b>
<b>Chapter 5</b>	<b>TM258LD42DT4L</b> . . . . .	<b>49</b>
	General Description . . . . .	<b>50</b>
	Characteristics of the Controller Power Distribution Module . . . . .	<b>54</b>
<b>Chapter 6</b>	<b>TM258LF42DT</b> . . . . .	<b>57</b>
	General Description . . . . .	<b>58</b>
	Characteristics of the Controller Power Distribution Module . . . . .	<b>62</b>
<b>Chapter 7</b>	<b>TM258LF42DT4L</b> . . . . .	<b>65</b>
	General Description . . . . .	<b>66</b>
	Characteristics of the Controller Power Distribution Module . . . . .	<b>70</b>
<b>Chapter 8</b>	<b>TM258LF66DT4L</b> . . . . .	<b>73</b>
	General Description . . . . .	<b>74</b>
	Characteristics of the Controller Power Distribution Module . . . . .	<b>78</b>
<b>Chapter 9</b>	<b>TM258LF42DR</b> . . . . .	<b>81</b>
	General Description . . . . .	<b>82</b>
	Characteristics of the Controller Power Distribution Module . . . . .	<b>86</b>
<b>Chapter 10</b>	<b>Power Distribution Wiring Diagram</b> . . . . .	<b>89</b>
	Wiring Diagram for External Power Supplies . . . . .	<b>89</b>

---

<b>Chapter 11</b>	<b>Integrated Communication Ports</b> .....	<b>91</b>
	Ethernet Port .....	<b>92</b>
	CAN Port .....	<b>96</b>
	USB Programming Port .....	<b>100</b>
	USB Host Port .....	<b>102</b>
	Serial Line Port .....	<b>104</b>
<b>Chapter 12</b>	<b>PCI Slots</b> .....	<b>109</b>
	PCI Slots .....	<b>109</b>
<b>Chapter 13</b>	<b>Embedded Expert I/O</b> .....	<b>111</b>
	Expert I/O .....	<b>112</b>
	Fast Inputs Characteristics .....	<b>117</b>
	Regular Inputs .....	<b>120</b>
	Fast Outputs .....	<b>122</b>
<b>Chapter 14</b>	<b>Embedded Regular I/O</b> .....	<b>125</b>
	Digital DI6DE .....	<b>126</b>
	Digital DI12DE .....	<b>130</b>
	Digital DO12TE .....	<b>134</b>
	Analog AI4LE .....	<b>139</b>
	Relay DO6RE .....	<b>143</b>
<b>Chapter 15</b>	<b>Connecting the Modicon M258 Logic Controller to a PC</b> ..	<b>149</b>
	Connecting the Controller to a PC .....	<b>149</b>
<b>Glossary</b>	.....	<b>151</b>
<b>Index</b>	.....	<b>161</b>

# Safety Information



## Important Information

### NOTICE

Read these instructions carefully, and look at the equipment to become familiar with the device before trying to install, operate, service, or maintain it. The following special messages may appear throughout this documentation or on the equipment to warn of potential hazards or to call attention to information that clarifies or simplifies a procedure.



The addition of this symbol to a “Danger” or “Warning” safety label indicates that an electrical hazard exists which will result in personal injury if the instructions are not followed.



This is the safety alert symbol. It is used to alert you to potential personal injury hazards. Obey all safety messages that follow this symbol to avoid possible injury or death.

## **DANGER**

**DANGER** indicates a hazardous situation which, if not avoided, **will result in death** or serious injury.

## **WARNING**

**WARNING** indicates a hazardous situation which, if not avoided, **could result in death** or serious injury.

## **CAUTION**

**CAUTION** indicates a hazardous situation which, if not avoided, **could result** in minor or moderate injury.

## **NOTICE**

**NOTICE** is used to address practices not related to physical injury.

---

## PLEASE NOTE

Electrical equipment should be installed, operated, serviced, and maintained only by qualified personnel. No responsibility is assumed by Schneider Electric for any consequences arising out of the use of this material.

A qualified person is one who has skills and knowledge related to the construction and operation of electrical equipment and its installation, and has received safety training to recognize and avoid the hazards involved.

## QUALIFICATION OF PERSONNEL

Only appropriately trained persons who are familiar with and understand the contents of this manual and all other pertinent product documentation are authorized to work on and with this product.

The qualified person must be able to detect possible hazards that may arise from parameterization, modifying parameter values and generally from mechanical, electrical, or electronic equipment. The qualified person must be familiar with the standards, provisions, and regulations for the prevention of industrial accidents, which they must observe when designing and implementing the system.

## INTENDED USE

The products described or affected by this document, together with software, accessories, and options, are programmable logic controllers (referred to herein as “logic controllers”), intended for industrial use according to the instructions, directions, examples, and safety information contained in the present document and other supporting documentation.

The product may only be used in compliance with all applicable safety regulations and directives, the specified requirements, and the technical data.

Prior to using the product, you must perform a risk assessment in view of the planned application. Based on the results, the appropriate safety-related measures must be implemented.

Since the product is used as a component in an overall machine or process, you must ensure the safety of persons by means of the design of this overall system.

Operate the product only with the specified cables and accessories. Use only genuine accessories and spare parts.

Any use other than the use explicitly permitted is prohibited and can result in unanticipated hazards.

---

# About the Book

---



## At a Glance

### Document Scope

The purpose of this document is to:

- show you how to install and operate your controller,
- show you how to connect the controller to a programming device equipped with EcoStruxure Machine Expert software
- help you understand how to interface the controller with I/O modules, HMI and other devices
- help you become familiar with the controller features.

**NOTE:** Read and understand this document and all related documents (*see page 8*) before installing, operating or maintaining your controller.

Users should read through the entire document to understand all its features.

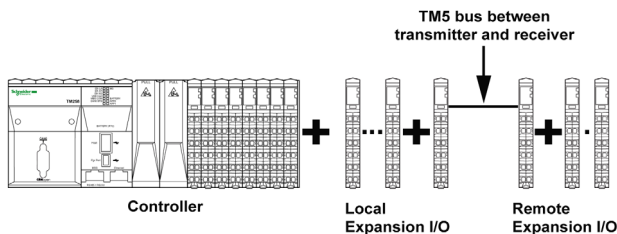

### Validity Note

This document has been updated for the release of EcoStruxure™ Machine Expert V1.2.5.

The technical characteristics of the devices described in the present document also appear online.

To access the information online, go to the Schneider Electric home page

<https://www.se.com/ww/en/download/>.

The characteristics that are described in the present document should be the same as those characteristics that appear online. In line with our policy of constant improvement, we may revise content over time to improve clarity and accuracy. If you see a difference between the document and online information, use the online information as your reference.

## Related Documents

Title of Documentation	Reference Number
Modicon M258 Logic Controller Programming Guide	<a href="#">EIO0000004135 (Eng)</a> <a href="#">EIO0000004136 (Fre)</a> <a href="#">EIO0000004137 (Ger)</a> <a href="#">EIO0000004138 (Spa)</a> <a href="#">EIO0000004139 (Ita)</a> <a href="#">EIO0000004140 (Chs)</a>
Modicon TM5 Flexible System - System Planning and Installation Guide	<a href="#">EIO0000003161 (ENG)</a> <a href="#">EIO0000003162 (FRE)</a> <a href="#">EIO0000003163 (GER)</a> <a href="#">EIO0000003164 (SPA)</a> <a href="#">EIO0000003165 (ITA)</a> <a href="#">EIO0000003166 (CHS)</a>
Modicon TM5 Digital I/O Modules Hardware Guide	<a href="#">EIO0000003197 (ENG)</a> <a href="#">EIO0000003198 (FRE)</a> <a href="#">EIO0000003199 (GER)</a> <a href="#">EIO0000003200 (SPA)</a> <a href="#">EIO0000003201 (ITA)</a> <a href="#">EIO0000003202 (CHS)</a>
Modicon TM5 Analog I/O Modules Hardware Guide	<a href="#">EIO0000003203 (ENG)</a> <a href="#">EIO0000003204 (FRE)</a> <a href="#">EIO0000003205 (GER)</a> <a href="#">EIO0000003206 (SPA)</a> <a href="#">EIO0000003207 (ITA)</a> <a href="#">EIO0000003208 (CHS)</a>
Modicon TM5 Expert (High Speed Counter) Modules Hardware Guide	<a href="#">EIO0000003209 (ENG)</a> <a href="#">EIO0000003210 (FRE)</a> <a href="#">EIO0000003211 (GER)</a> <a href="#">EIO0000003212 (SPA)</a> <a href="#">EIO0000003213 (ITA)</a> <a href="#">EIO0000003214 (CHS)</a>
Modicon TM5 Transmitter and Receiver Modules Hardware Guide	<a href="#">EIO0000003215 (ENG)</a> <a href="#">EIO0000003216 (FRE)</a> <a href="#">EIO0000003217 (GER)</a> <a href="#">EIO0000003218 (SPA)</a> <a href="#">EIO0000003219 (ITA)</a> <a href="#">EIO0000003220 (CHS)</a>



Title of Documentation	Reference Number
TM5 PCI Communication Modules Hardware Guide	<a href="#">EIO0000003173 (ENG)</a> <a href="#">EIO0000003174 (FRE)</a> <a href="#">EIO0000003175 (GER)</a> <a href="#">EIO0000003176 (SPA)</a> <a href="#">EIO0000003177 (ITA)</a> <a href="#">EIO0000003178 (CHS)</a>
Modicon M258 Logic Controller Instruction Sheet	<a href="#">BBV56040</a>

You can download these technical publications and other technical information from our website at <https://www.se.com/ww/en/download/> .

### Product Related Information

DANGER

**HAZARD OF ELECTRIC SHOCK, EXPLOSION OR ARC FLASH**

- Disconnect all power from all equipment including connected devices prior to removing any covers or doors, or installing or removing any accessories, hardware, cables, or wires except under the specific conditions specified in the appropriate hardware guide for this equipment.
- Always use a properly rated voltage sensing device to confirm the power is off where and when indicated.
- Replace and secure all covers, accessories, hardware, cables, and wires and confirm that a proper ground connection exists before applying power to the unit.
- Use only the specified voltage when operating this equipment and any associated products.

**Failure to follow these instructions will result in death or serious injury.**

DANGER

**POTENTIAL FOR EXPLOSION**

- Only use this equipment in non-hazardous locations, or in locations that comply with Class I, Division 2, Groups A, B, C and D.
- Do not substitute components which would impair compliance to Class I, Division 2.
- Do not connect or disconnect equipment unless power has been removed or the location is known to be non-hazardous.
- Do not use the USB port(s), if so equipped, unless the location is known to be non-hazardous.

**Failure to follow these instructions will result in death or serious injury.**

---

## WARNING

### LOSS OF CONTROL

- The designer of any control scheme must consider the potential failure modes of control paths and, for certain critical control functions, provide a means to achieve a safe state during and after a path failure. Examples of critical control functions are emergency stop and overtravel stop, power outage and restart.
- Separate or redundant control paths must be provided for critical control functions.
- System control paths may include communication links. Consideration must be given to the implications of unanticipated transmission delays or failures of the link.
- Observe all accident prevention regulations and local safety guidelines.<sup>1</sup>
- Each implementation of this equipment must be individually and thoroughly tested for proper operation before being placed into service.

**Failure to follow these instructions can result in death, serious injury, or equipment damage.**

<sup>1</sup> For additional information, refer to NEMA ICS 1.1 (latest edition), "Safety Guidelines for the Application, Installation, and Maintenance of Solid State Control" and to NEMA ICS 7.1 (latest edition), "Safety Standards for Construction and Guide for Selection, Installation and Operation of Adjustable-Speed Drive Systems" or their equivalent governing your particular location.

## WARNING

### UNINTENDED EQUIPMENT OPERATION

- Only use software approved by Schneider Electric for use with this equipment.
- Update your application program every time you change the physical hardware configuration.

**Failure to follow these instructions can result in death, serious injury, or equipment damage.**

---

## Terminology Derived from Standards

The technical terms, terminology, symbols and the corresponding descriptions in this manual, or that appear in or on the products themselves, are generally derived from the terms or definitions of international standards.

In the area of functional safety systems, drives and general automation, this may include, but is not limited to, terms such as *safety*, *safety function*, *safe state*, *fault*, *fault reset*, *malfunction*, *failure*, *error*, *error message*, *dangerous*, etc.

Among others, these standards include:

Standard	Description
IEC 61131-2:2007	Programmable controllers, part 2: Equipment requirements and tests.
ISO 13849-1:2015	Safety of machinery: Safety related parts of control systems. General principles for design.
EN 61496-1:2013	Safety of machinery: Electro-sensitive protective equipment. Part 1: General requirements and tests.
ISO 12100:2010	Safety of machinery - General principles for design - Risk assessment and risk reduction
EN 60204-1:2006	Safety of machinery - Electrical equipment of machines - Part 1: General requirements
ISO 14119:2013	Safety of machinery - Interlocking devices associated with guards - Principles for design and selection
ISO 13850:2015	Safety of machinery - Emergency stop - Principles for design
IEC 62061:2015	Safety of machinery - Functional safety of safety-related electrical, electronic, and electronic programmable control systems
IEC 61508-1:2010	Functional safety of electrical/electronic/programmable electronic safety-related systems: General requirements.
IEC 61508-2:2010	Functional safety of electrical/electronic/programmable electronic safety-related systems: Requirements for electrical/electronic/programmable electronic safety-related systems.
IEC 61508-3:2010	Functional safety of electrical/electronic/programmable electronic safety-related systems: Software requirements.
IEC 61784-3:2016	Industrial communication networks - Profiles - Part 3: Functional safety fieldbuses - General rules and profile definitions.
2006/42/EC	Machinery Directive
2014/30/EU	Electromagnetic Compatibility Directive
2014/35/EU	Low Voltage Directive

---

In addition, terms used in the present document may tangentially be used as they are derived from other standards such as:

Standard	Description
IEC 60034 series	Rotating electrical machines
IEC 61800 series	Adjustable speed electrical power drive systems
IEC 61158 series	Digital data communications for measurement and control – Fieldbus for use in industrial control systems

Finally, the term *zone of operation* may be used in conjunction with the description of specific hazards, and is defined as it is for a *hazard zone* or *danger zone* in the *Machinery Directive (2006/42/EC)* and *ISO 12100:2010*.

**NOTE:** The aforementioned standards may or may not apply to the specific products cited in the present documentation. For more information concerning the individual standards applicable to the products described herein, see the characteristics tables for those product references.

---

# Chapter 1

## TM5 System General Rules for Implementing

---

### What Is in This Chapter?

This chapter contains the following topics:

Topic	Page
Installation and Maintenance Requirements	14
Wiring Best Practices	17
TM5 Environmental Characteristics	23

## Installation and Maintenance Requirements

### Before Starting

Read and understand this chapter before beginning the installation of your TM5 System.

The use and application of the information contained herein require expertise in the design and programming of automated control systems. Only you, the user, machine builder or integrator, can be aware of all the conditions and factors present during installation and setup, operation, and maintenance of the machine or process, and can therefore determine the automation and associated equipment and the related safeties and interlocks which can be effectively and properly used. When selecting automation and control equipment, and any other related equipment or software, for a particular application, you must also consider any applicable local, regional or national standards and/or regulations.

Pay particular attention in conforming to any safety information, different electrical requirements, and normative standards that would apply to your machine or process in the use of this equipment.

### ***NOTICE***

#### **ELECTROSTATIC DISCHARGE**

- Store all components in their protective packaging until immediately before assembly.
- Never touch exposed conductive parts such as contacts or terminals.

**Failure to follow these instructions can result in equipment damage.**

### Disconnecting Power

All options and modules should be assembled and installed before installing the control system on a mounting rail, onto a mounting plate or in a panel. Remove the control system from its mounting rail, mounting plate or panel before disassembling the equipment.

### **DANGER**

#### **HAZARD OF ELECTRIC SHOCK, EXPLOSION OR ARC FLASH**

- Disconnect all power from all equipment including connected devices prior to removing any covers or doors, or installing or removing any accessories, hardware, cables, or wires except under the specific conditions specified in the appropriate hardware guide for this equipment.
- Always use a properly rated voltage sensing device to confirm the power is off where and when indicated.
- Replace and secure all covers, accessories, hardware, cables, and wires and confirm that a proper ground connection exists before applying power to the unit.
- Use only the specified voltage when operating this equipment and any associated products.

**Failure to follow these instructions will result in death or serious injury.**

## Programming Considerations

### WARNING

#### UNINTENDED EQUIPMENT OPERATION

- Only use software approved by Schneider Electric for use with this equipment.
- Update your application program every time you change the physical hardware configuration.

**Failure to follow these instructions can result in death, serious injury, or equipment damage.**

## Operating Environment

### DANGER

#### POTENTIAL FOR EXPLOSION

- Only use this equipment in non-hazardous locations, or in locations that comply with Class I, Division 2, Groups A, B, C and D.
- Do not substitute components which would impair compliance to Class I, Division 2.
- Do not connect or disconnect equipment unless power has been removed or the location is known to be non-hazardous.
- Do not use the USB port(s), if so equipped, unless the location is known to be non-hazardous.

**Failure to follow these instructions will result in death or serious injury.**

### WARNING

#### UNINTENDED EQUIPMENT OPERATION

Install and operate this equipment according to the conditions described in the Environmental Characteristics.

**Failure to follow these instructions can result in death, serious injury, or equipment damage.**

**NOTE:** Individual I/O modules may differ in terms of operating temperature de-ratings or other important environmental characteristics. For the specific information, refer to the hardware guide for your particular module.

## Installation Considerations

### **WARNING**

#### **UNINTENDED EQUIPMENT OPERATION**

- Use appropriate safety interlocks where personnel and/or equipment hazards exist.
- Install and operate this equipment in an enclosure appropriately rated for its intended environment and secured by a keyed or tooled locking mechanism.
- Use the sensor and actuator power supplies only for supplying power to the sensors or actuators connected to the module.
- Power line and output circuits must be wired and fused in compliance with local and national regulatory requirements for the rated current and voltage of the particular equipment.
- Do not use this equipment in safety-critical machine functions unless the equipment is otherwise designated as functional safety equipment and conforming to applicable regulations and standards.
- Do not disassemble, repair, or modify this equipment.
- Do not connect any wiring to reserved, unused connections, or to connections designated as No Connection (N.C.).

**Failure to follow these instructions can result in death, serious injury, or equipment damage.**

**NOTE:** JDYX2 or JDYX8 fuse types are UL-recognized and CSA approved.



## Wiring Best Practices

### Introduction

There are several rules that must be followed when wiring the TM5 System.

### Wiring Rules



#### **HAZARD OF ELECTRIC SHOCK, EXPLOSION OR ARC FLASH**

- Disconnect all power from all equipment including connected devices prior to removing any covers or doors, or installing or removing any accessories, hardware, cables, or wires except under the specific conditions specified in the appropriate hardware guide for this equipment.
- Always use a properly rated voltage sensing device to confirm the power is off where and when indicated.
- Replace and secure all covers, accessories, hardware, cables, and wires and confirm that a proper ground connection exists before applying power to the unit.
- Use only the specified voltage when operating this equipment and any associated products.

**Failure to follow these instructions will result in death or serious injury.**

The following rules must be applied when wiring the TM5 System:

- I/O and communication wiring must be kept separate from the power wiring. Route these 2 types of wiring in separate cable ducting.
- Verify that the operating conditions and environment are within the specification values.
- Use proper wire sizes to meet voltage and current requirements.
- Use copper conductors only.
- Use twisted pair, shielded cables for analog, expert, or fast I/O and TM5 bus signals.
- Use twisted pair, shielded cables for encoder, networks and fieldbus (CAN, serial, Ethernet).

Use shielded, properly grounded cables for all analog and high-speed inputs or outputs and communication connections. If you do not use shielded cable for these connections, electromagnetic interference can cause signal degradation. Degraded signals can cause the controller or attached modules and equipment to perform in an unintended manner.

## ⚠ WARNING





### UNINTENDED EQUIPMENT OPERATION

- Use shielded cables for all fast I/O, analog I/O and communication signals.
- Ground cable shields for all analog I/O, fast I/O and communication signals at a single point<sup>1</sup>.
- Route communication and I/O cables separately from power cables.





**Failure to follow these instructions can result in death, serious injury, or equipment damage.**

<sup>1</sup>Multipoint grounding is permissible if connections are made to an equipotential ground plane dimensioned to help avoid cable shield damage in the event of power system short-circuit currents. Refer to the section Grounding the TM5 System to ground the shielded cables.

This table provides the wire sizes to use with the removable spring terminal blocks (TM5ACTB06, TM5ACTB12, TM5ACTB12, TM5ACTB12PS, TM5ACTB32):

mm in. 				
mm <sup>2</sup>	0,08...2,5	0,25...2,5	0,25...1,5	2 x 0,25...2 x 0,75
AWG	28...14	24...14	24...16	2 x 24...2 x 18

This table provides the wire sizes to use with the TM5ACTB16 terminal blocks:

mm in. 			
mm <sup>2</sup>	0,08...1,5	0,25...1,5	0,25...0,75
AWG	28...16	24...16	24...20

## ⚠ DANGER

### FIRE HAZARD

Use only the correct wire sizes for the maximum current capacity of the I/O channels and power supplies.

**Failure to follow these instructions will result in death or serious injury.**

The spring clamp connectors of the terminal block are designed for only one wire or one cable end. Two wires to the same connector must be installed with a double wire cable end to help prevent loosening.

 **DANGER****LOOSE WIRING CAUSES ELECTRIC SHOCK**

Do not insert more than one wire per connector of the spring terminal blocks unless using a double wire cable end (ferrule).

**Failure to follow these instructions will result in death or serious injury.**

**TM5 Terminal Block**

Inserting an incorrect terminal block into the electronic module can cause unintended operation of the application and/or damage the electronic module.

 **DANGER****ELECTRIC SHOCK OR UNINTENDED EQUIPMENT OPERATION**

Connect the terminal blocks to their designated location.

**Failure to follow these instructions will result in death or serious injury.**

**NOTE:** To help prevent a terminal block from being inserted incorrectly, ensure that each terminal block and electronic module is clearly and uniquely coded.

### TM5 Strain Relief Using Cable Tie

There are 2 methods to reduce the stress on cables:

- The terminal blocks have slots to attach cable ties. A cable tie can be fed through this slot to secure cables and wires to reduce stress between them and the terminal block connections.
- After grounding the TM5 System by means of the grounding plate TM2XMTGB, wires can be bundled and affixed to the grounding plate tabs using wire ties to reduce stress on the cables.

The following table provides the size of the cable tie and presents the two methods to reduce the stress on the cables:

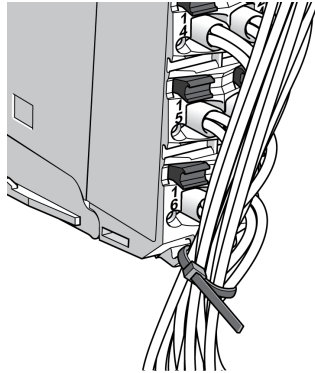
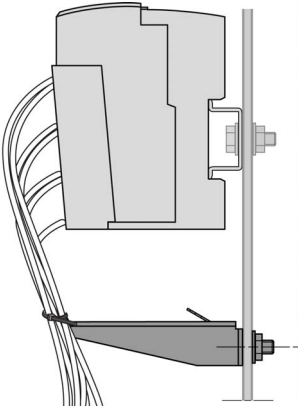
Cable Tie Size	Terminal Block	TM2XMTGB Grounding Plate
Thickness	1.2 mm (0.05 in.) maximum	1.2 mm (0.05 in.)
Width	4 mm (0.16 in.) maximum	2.5...3 mm (0.1...0.12 in.)
Mounting illustration		

## **⚠ WARNING**

### **ACCIDENTAL DISCONNECTION FROM PROTECTIVE GROUND (PE)**

- Do not use the TM2XMTGB Grounding Plate to provide a protective ground (PE).
- Use the TM2XMTGB Grounding Plate only to provide a functional ground (FE).

**Failure to follow these instructions can result in death, serious injury, or equipment damage.**

## Protecting Outputs from Inductive Load Damage

Depending on the load, a protection circuit may be needed for the outputs on the controllers and certain modules. Inductive loads using DC voltages may create voltage reflections resulting in overshoot that will damage or shorten the life of output devices.

### ⚠ WARNING

#### INDUCTIVE LOADS

Use an appropriate external protective circuit or device to reduce the risk of inductive direct current load damage.

**Failure to follow these instructions can result in death, serious injury, or equipment damage.**

If your controller or module contains relay outputs, these types of outputs can support up to 240 Vac. Inductive damage to these types of outputs can result in welded contacts and loss of control. Each inductive load must include a protection device such as a peak limiter, RC circuit or flyback diode. Capacitive loads are not supported by these relays.

### ⚠ WARNING

#### RELAY OUTPUTS WELDED CLOSED

- Always protect relay outputs from inductive alternating current load damage using an appropriate external protective circuit or device.
- Do not connect relay outputs to capacitive loads.

**Failure to follow these instructions can result in death, serious injury, or equipment damage.**

**Protective circuit A:** this protection circuit can be used for both AC and DC load power circuits.

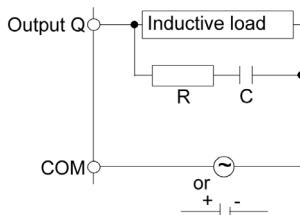

**C** Value from 0.1 to 1  $\mu\text{F}$

**R** Resistor of approximately the same resistance value as the load

**Protective circuit B:** this protection circuit can be used for DC load power circuits.

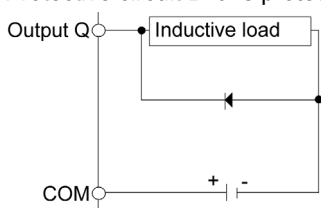

Use a diode with the following ratings:

- Reverse withstand voltage: power voltage of the load circuit x10.
- Forward current: more than the load current.

**Protective circuit C:** this protection circuit can be used for both AC and DC load power circuits.

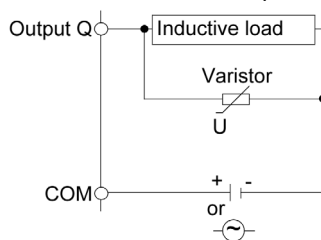

In applications where the inductive load is switched on and off frequently and/or rapidly, ensure that the continuous energy rating (J) of the varistor exceeds the peak load energy by 20 % or more.

## TM5 Environmental Characteristics

### Enclosure Requirements

TM5 components are designed as Zone B, Class A industrial equipment according to IEC/CISPR Publication 11. If they are used in environments other than those described in the standard, or in environments that do not meet the specifications in this manual, your ability to meet electromagnetic compatibility requirements in the presence of conducted and/or radiated interference may be reduced.

The TM5 components meet European Community (CE) requirements for open equipment as defined by EN61131-2. You must install them in an enclosure designed for the specific environmental conditions and to minimize the possibility of unintended contact with hazardous voltages. The enclosure should be constructed of metal to improve the electromagnetic immunity of your TM5 System. The enclosure should, and in the case of UL compliance, must, have a keyed locking mechanism to minimize unauthorized access.

### Environmental Characteristics

This equipment meets UL and CSA standards and carry both certification marks. In addition, it is certified as CE compliant. This equipment is intended for use in a Pollution Degree 2 industrial environment.

The table below provides the general environmental characteristics:

Characteristic	Minimum Specification	Tested Range	
Standard	IEC61131-2	–	
Agencies	UL 508 CSA 22.2 No. 142-M1987 CSA 22.2 No. 213-M1987	–	
Ambient operating temperature	–	Horizontal installation	0...55 °C (32...131 °F)
	–	Vertical installation	0...50 °C (32...122 °F)
Storage temperature	–	-25...70 °C (-13...158 °F)	
Relative humidity	–	5...95% (non-condensing)	
Degree of pollution	IEC60664	2	
Degree of protection	IEC61131-2	IP20	
Corrosion immunity	None	–	
Operating altitude	–	0...2000 m (0...6.560 ft.)	
Storage altitude	–	0...3000 m (0...9.842 ft.)	
<b>NOTE:</b> The tested ranges may indicate values beyond that of the IEC Standard. However, our internal standards define what is necessary for industrial environments. In all cases, we uphold the minimum specification if indicated.			

Characteristic		Minimum Specification	Tested Range
Vibration resistance		–	Mounted on a DIN rail 3.5 mm (0.138 in.) fixed amplitude from 5...8.4 Hz 9.8 m/s <sup>2</sup> (1 g <sub>n</sub> ) fixed acceleration from 8.4...150 Hz
Mechanical shock resistance		–	147 m/s <sup>2</sup> (15 g <sub>n</sub> ) for a duration of 11 ms
Connection type	Removable spring terminal block	–	–
Connector insertion/removal cycles		–	50
<b>NOTE:</b> The tested ranges may indicate values beyond that of the IEC Standard. However, our internal standards define what is necessary for industrial environments. In all cases, we uphold the minimum specification if indicated.			

**NOTE:** Replacement of the battery in the controllers other than with the type specified in this documentation may present a risk of fire or explosion.

For more details on the procedures for replacing lithium batteries, refer to the RTC chapter (*see page 35*).

** WARNING**

**IMPROPER BATTERY CAN PROVOKE FIRE OR EXPLOSION**

Replace battery only with identical type: Renata Type CR2477M.

**Failure to follow these instructions can result in death, serious injury, or equipment damage.**



## Electromagnetic Susceptibility

The following table provides the TM5 System electromagnetic susceptibility specifications:

Characteristic	Minimum Specification	Tested Range
Electrostatic discharge	IEC/EN 61000-4-2	8 kV (air discharge), criteria B 4 kV (contact discharge), criteria B
Electromagnetic fields	IEC/EN 61000-4-3	10 V/m (80 MHz...2 GHz), criteria A 10 V/m (80 MHz...2.7 GHz) <sup>(1)</sup>
Fast transients burst	IEC/EN 61000-4-4	Power lines: 2 kV, criteria B I/O: 1 kV, criteria B Shielded cable: 1 kV, criteria B Repetition rate: 5 and 100 KHz
Surge immunity 24 Vdc circuit	IEC/EN 61000-4-5	1 kV in common mode, criteria B 0.5 kV in differential mode, criteria B
Surge immunity 230 Vac circuit	IEC/EN 61000-4-5	2 kV in common mode, criteria B 1 kV in differential mode, criteria B
Induced electromagnetic field	IEC/EN 61000-4-6	10 V <sub>eff</sub> (0.15...80 MHz), criteria A
Conducted emission	EN 55011 (IEC/CISPR11)	150...500 kHz, quasi peak 79 dB (µV) 500 kHz...30 MHz, quasi peak 73 dB (µV)
Radiated emission	EN 55011 (IEC/CISPR11)	30...230 MHz, 10 m@40 dB (µV/m) 230 MHz...1 GHz, 10 m@47 dB (µV/m)
<p><b>Criteria A</b> Uninterrupted operation during test.  <b>Criteria B</b> Brief interruption during the test allowed.  <b>(1)</b> Applies for TM5SE11C20005 and TM5SE1MISC20005.</p> <p><b>NOTE:</b> The tested ranges may indicate values beyond that of the IEC Standard. However, our internal standards define what is necessary for industrial environments. In all cases, we uphold the minimum specification if indicated.</p>		



---

# Chapter 2

## Modicon M258 Logic Controller Features

---

### Introduction

This chapter describes the features of the Modicon M258 Logic Controller.

### What Is in This Chapter?

This chapter contains the following topics:

Topic	Page
About the Modicon M258 Logic Controller	28
Controller Description	30
Controller Common Characteristics	31
Real Time Clock (RTC)	34

## About the Modicon M258 Logic Controller

### Overview

The Schneider Electric Modicon M258 Logic Controller is a controller with a variety of features. The Software configuration is described in the EcoStruxure Machine Expert Programming Guide.

### Key Features

The EcoStruxure Machine Expert software supports the following IEC61131-3 programming languages for use with these controllers:

- IL: Instruction List
- LD: Ladder Diagram
- ST: Structured Text
- FBD: Function Block Diagram
- SFC: Sequential Function Chart

EcoStruxure Machine Expert software can also be used to program these controllers using CFC (Continuous Function Chart) language.

The controllers support the following fieldbuses and network capabilities:

- CANopen Master
- Ethernet
- Serial Line

The controllers support the following functions and I/O types:

- Expert functions (counting, reflex outputs...)
- Embedded I/Os

The controllers support up to 21 application program tasks with the following limits:

- 4 cyclic tasks: one is configured by default (MAST)
- 1 freewheeling task
- 8 software event driven tasks
- 8 hardware event driven tasks

## Controller Range

	PCI	CAN	USB A	USB Pgr	Ethernet	Serial Line
TM258LD42DT <i>(see page 41)</i>	0	0	1	1	1	1
TM258LD42DT4L <i>(see page 49)</i>	2	0	1	1	1	1
TM258LF42DT <i>(see page 57)</i>	0	1	1	1	1	1
TM258LF42DT4L <i>(see page 65)</i>	2	1	1	1	1	1
TM258LF66DT4L <i>(see page 73)</i>	2	1	1	1	1	1
TM258LF42DR <i>(see page 81)</i>	2	1	1	1	1	1

	Embedded Expert I/O				Embedded Regular I/O			
		Fast Inputs	Fast Outputs	Regular Inputs		Digital Inputs	Digital Outputs	Analog Inputs
TM258LD42DT <i>(see page 41)</i>	2x	5	2	2	1x	12	12	0
TM258LD42DT4L <i>(see page 49)</i>	2x	5	2	2	1x	12	12	4
TM258LF42DT <i>(see page 57)</i>	2x	5	2	2	1x	12	12	0
TM258LF42DT4L <i>(see page 65)</i>	2x	5	2	2	1x	12	12	4
TM258LF66DT4L <i>(see page 73)</i>	2x	5	2	2	2x	12	12	4
TM258LF42DR <i>(see page 81)</i>	2x	5	2	2	2x	6	6 Relays	0

## Controller Description

### Overview

The Modicon M258 Logic Controller and its range are described below.

### Physical Description

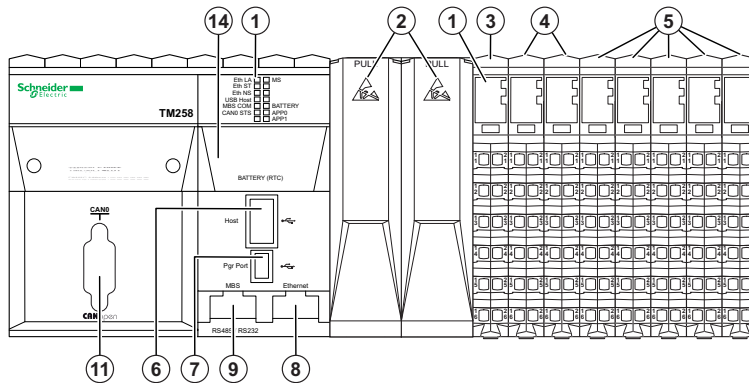

- 1 LED Status
- 2 PCI slots (depending on the controller reference)
- 3 Controller Power Distribution Module (CPDM)
- 4 Expert I/O (Embedded)
- 5 Regular I/O (Embedded)
- 6 USB A port (Host)
- 7 USB programming port (Pgr Port)
- 8 Ethernet port (Ethernet)
- 9 Serial Line port (MBS)
- 11 CANopen port (CAN0)
- 14 Real Time Clock battery (Battery (RTC))

## Controller Common Characteristics

### Overview

The common characteristics for all the Modicon M258 Logic Controllers are described below.

### Programming

Use the EcoStruxure Machine Expert software to program the controller.

## ⚠ WARNING

### UNINTENDED EQUIPMENT OPERATION

- Only use software approved by Schneider Electric for use with this equipment.
- Update your application program every time you change the physical hardware configuration.

**Failure to follow these instructions can result in death, serious injury, or equipment damage.**

EcoStruxure Machine Expert is a professional, efficient and open OEM software solution that helps you develop, configure and commission the entire machine in a single environment (including logic, motor control, HMI and related network automation functions).

All information about EcoStruxure Machine Expert is included in the global EcoStruxure Machine Expert software help system.

### Memory

The following table describes the different kinds of memory:

Memory type	Size	Used
RAM	64 Mbytes	To execute the application.
Flash	128 Mbytes	To save program and data in case of a power outage.

### Embedded Communication features

The four kinds of ports on the controller front panel are:

- Ethernet port
- CAN ports
- USB ports
- Serial Line Port

For more details, refer to the chapter Integrated Communication Ports (*see page 91*).

## PCI

The communication electronic module range includes:

- RS232 connection electronic modules
- RS485 connection electronic modules (for Serial Line and Profibus DP)

## Controller Power Distribution Module (CPDM)

The controller power distribution module is divided into 3 power circuits:

- 24 Vdc Embedded expert modules power
- 24 Vdc Main power (for controller, fieldbus and TM5 power bus)
- 24 Vdc I/O power segment

There is no configuration necessary for this module.

## Embedded Expert Input/Output

The controller base provides:

- 2 Embedded Expert I/O modules (DM72F0 and DM72F1) each with:
  - 5 fast inputs
  - 2 regular inputs
  - 2 fast outputs

## Embedded Regular Input/Output

The Embedded Regular I/O may include, depending on the controller range:

- digital input electronic modules
- digital output electronic modules
- analog input electronic modules
- relay output electronic modules

Every digital and analog electronic module channel has a status LED.



## Expansion Modules

You can expand the number of I/Os for your controller by adding expansion I/O slices. The following table lists the different types of electronic modules available to create expansion I/O slices:

Reference	Description
TM5C••	Compact I/O modules
TM5SD••	Digital modules
TM5SA••	Analog modules
TM5SPS••	Power distribution modules
TM5SE••	Specialized expansion modules
TM5SBE••	Transmitter and receiver modules
TM5SPD••	Common Distribution Module
TM5SD000	Dummy module

## Real Time Clock (RTC)

### Overview

These controllers include an RTC to provide system date and time information, and to support related functions requiring a real-time clock. To continue to keep time when power is removed, a non-rechargeable but replaceable battery is delivered with the controller. A battery LED indicates if the battery charge is low or the battery absent.

The following table shows how RTC drift is managed:

RTC characteristics	Description
RTC drift	Less than 30 seconds per month without any user calibration at 25°C (77°F).
RTC drift with user logic assistance	Less than or equal to 6 seconds per month with user calibration through application software when the controller is in RUN mode.

### RTC Battery

The controller has one RTC battery.

In the event of a power outage, the backup battery will retain the time of the controller.

The table below shows the characteristics of the RTC battery:

<b>Use</b>	In the event of a transient power outage, the battery will power the RTC.
<b>Backup Time</b>	At least 1.5 years at 45°C max (113°F). At higher temperatures, the time is reduced.
<b>Battery Monitoring Features</b>	Yes.
<b>Replaceable</b>	Yes.
<b>Controller RTC Battery Type</b>	Type BBCV2, Renata Type CR2477M.

## Installing and Replacing the RTC battery

While lithium batteries are preferred due to their slow discharge and long life, they can present hazards to personnel, equipment and the environment and must be handled properly.

### **⚠ DANGER**

#### **EXPLOSION, FIRE, OR CHEMICAL BURNS**

- Replace with identical battery type.
- Follow all the instructions of the battery manufacturer.
- Remove all replaceable batteries before discarding unit.
- Recycle or properly dispose of used batteries.
- Protect battery from any potential short-circuit.
- Do not recharge, disassemble, heat above 100 °C (212 °F), or incinerate.
- Use your hands or insulated tools to remove or replace the battery.
- Maintain proper polarity when inserting and connecting a new battery.

**Failure to follow these instructions will result in death or serious injury.**

To install or replace the RTC battery, follow these steps:

Step	Action
1	Remove all power from your controller.
2	Slide out the battery holder of the controller:

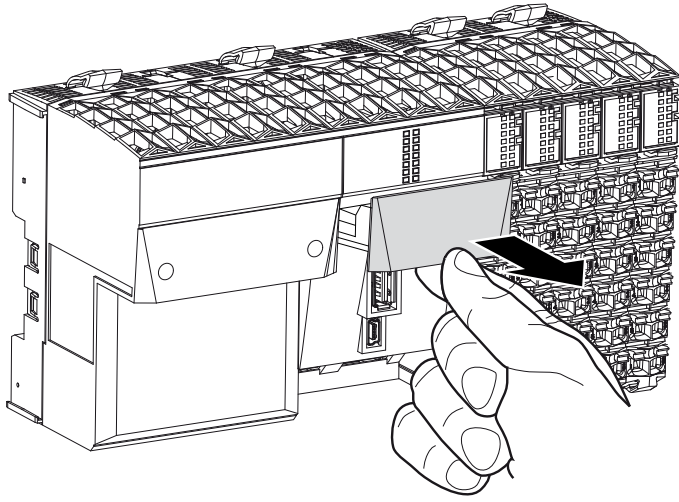

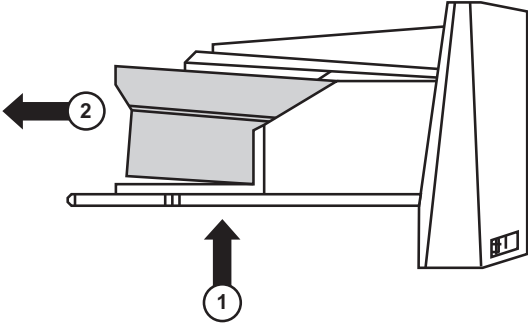
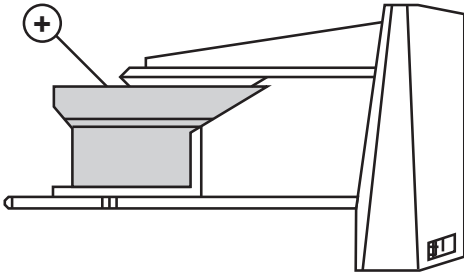
Step	Action
3	<p>Remove the battery from the battery holder:</p> 
4	<p>Insert the new battery into the battery holder in accordance with the polarity markings on the battery:</p> 
5	<p>Replace the battery holder on the controller and verify that the latch clicks into place.</p>
6	<p>Re-apply power to the Modicon M258 Logic Controller.</p> <p><b>NOTE:</b> If you do not apply power to the Modicon M258 Logic Controller immediately, the external backup battery life might be significantly reduced.</p>
7	<p>Set the internal clock. For further details on the internal clock, please refer to RTC Library.</p>

**NOTE:** Replacement of the battery in the controllers other than with the type specified in this documentation may present a risk of fire or explosion.

 **WARNING**

**IMPROPER BATTERY CAN PROVOKE FIRE OR EXPLOSION**

Replace battery only with identical type: Renata Type CR2477M.

**Failure to follow these instructions can result in death, serious injury, or equipment damage.**



---

# Chapter 3

## Modicon M258 Logic Controller Installation

---

### First Startup

#### Overview

This procedure helps you through the installation and startup of your controller.

#### Startup Procedure

Step	Action	Comment
1	Unpack your controller and check the contents of the package.	Contents of package: Instruction Sheet, Controller, Terminal blocks to be mounted on the controller, RTC battery in a separate bag
2	Choose an appropriate cabinet and DIN rail and install them.	Refer to the Modicon Flexible TM5 System - System Planning and Installation Guide.
3	Plug your controller on the DIN rail.	
4	Connect your PCI expansion modules to the controller.	Refer to the PCI Slots ( <i>see page 109</i> ).
5	Connect the expansion I/O slices (optional).	Refer to the Modicon Flexible TM5 System - System Planning and Installation Guide.
6	Connect your devices to the inputs and outputs.	Refer to Modicon TM5 Analog I/O Modules Hardware Guide and Modicon TM5 Digital I/O Modules Hardware Guide.
7	Connect the external 24 Vdc power source(s) Controller Power Distribution Module (CPDM) and any optional Power Distribution Modules (PDM).	Refer to CPDM Wiring Diagram ( <i>see page 89</i> ).
8	Connect your controller to the PC. <b>NOTE:</b> EcoStruxure Machine Expert must be installed on the PC.	Refer to Connecting the Controller to a PC ( <i>see page 149</i> ).
9	Verify all connections.	—
10	Apply power.	—
11	Login to your controller.	—
12	Create an application.	—
13	Load your application into the controller.	—

Step	Action	Comment
14	Create your boot application.	—
15	Run the application.	—



---

# Chapter 4

## TM258LD42DT

---

### Introduction

This chapter describes the TM258LD42DT controller.

### What Is in This Chapter?

This chapter contains the following topics:

Topic	Page
General Description	42
Characteristics of the Controller Power Distribution Module	46

## General Description

### Overview

The following illustration describes the different components of the TM258LD42DT:

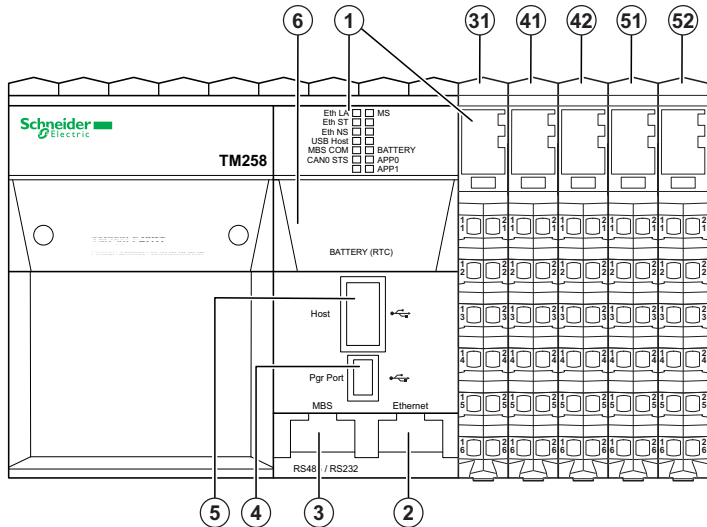

N°	Designation / Description	Refer to
1	LED status	Status LEDs ( <a href="#">see page 43</a> )
2	Ethernet port / Type RJ45	Ethernet Port ( <a href="#">see page 92</a> )
3	Serial line / Type RJ45 (RS232 or RS485)	Serial Line Port ( <a href="#">see page 104</a> )
4	USB programming port / For terminal connection to a programming PC (EcoStruxure Machine Expert)	USB Programming Port ( <a href="#">see page 100</a> )
5	USB host / For memory key management	USB Host Port ( <a href="#">see page 102</a> )
6	Battery	RTC Battery ( <a href="#">see page 34</a> )
31	Controller Power Distribution Module / For connecting external power supplies	Controller Power Distribution Module ( <a href="#">see page 32</a> )
41	Embedded Expert I/O modules / 5 fast inputs, 2 regular inputs, 2 fast outputs	Embedded Expert I/O ( <a href="#">see page 111</a> )
42		
51	Embedded Regular Input module / 12 digital inputs	Digital DI12DE ( <a href="#">see page 130</a> )
52	Embedded Regular Output module / 12 digital outputs	Digital DO12TE ( <a href="#">see page 134</a> )

## Status LEDs

### General Description

Eth LA	<input type="checkbox"/>	<input checked="" type="checkbox"/>	MS
Eth ST	<input type="checkbox"/>	<input type="checkbox"/>	
Eth NS	<input type="checkbox"/>	<input type="checkbox"/>	
USB Host	<input type="checkbox"/>	<input type="checkbox"/>	
MBS COM	<input type="checkbox"/>	<input checked="" type="checkbox"/>	BATTERY
CAN0 STS	<input type="checkbox"/>	<input checked="" type="checkbox"/>	APP0
	<input type="checkbox"/>	<input checked="" type="checkbox"/>	APP1

The following table describes the controller status LEDs:

Marking	Description	LED	
		Color	Description
MS	Module status	Green / Red	See MS status LED below
BATTERY	Battery status	Red	On when RTC battery needs to be replaced
APP0	Application LEDs	Green / Red	Managed by user application
APP1			

The following table describes the MS status LED:

Status LED	Controller State	Prg Port Communication	Application Execution
Flashing green / red	BOOTING	No	No
Flashing red	INVALID OS	Restricted	No
Single flash green	EMPTY	Yes	No
Green ON	RUNNING	Yes	Yes
3 flash green	RUNNING with Breakpoint	Yes	Restricted
Flashing green	STOPPED	Restricted	No
Single flash red	HALT	Yes	No
Rapid flashing red	REBOOT after a hardware error has been detected	Yes	No (Empty)
Red ON	HALT after system error detected	No	No
OFF	No power	No	No
Green / with single flash red	RUNNING with external error detected Or different Boot Project Or no Boot Project	Yes	Yes
Flashing green / with single flash red	STOPPED with external error detected	Restricted	No

**NOTE:** For further details on controller states, refer to the Operating Mode discussion in the Programming Guide for your particular controller.

For further details on the following LEDs:

- Eth LA, Eth ST and Eth NS, please refer to Ethernet Port - Status LEDs (*see page 94*).
- USB Host, please refer to USB Host Port - Status LED (*see page 103*).
- MBS COM, please refer to Serial Line Port - Status LED (*see page 107*).
- CAN0 STS, please refer to CAN Port - Status LED (*see page 99*).

**Identifying the logic controller**

The following illustration shows the LEDs on the front panel display:

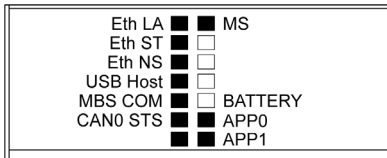

The LEDs flash when the logic controller is being identified. For more information, refer to EcoStruxure Machine Expert Programming Guide.

**Controller States**

The following table describes the controller states:

State	Description
BOOTING	The controller executes the boot firmware and its own internal self tests. It does not execute the application nor does it communicate. It then checks the checksum of the firmware and user application.
INVALID_OS	The Operating System is not valid. The controller can not execute an application. Communications are restricted.
EMPTY	The user application is not valid or a hardware error has been detected. The controller does not execute the application but it can communicate.
RUNNING	The controller executes the application.
STOPPED	The controller has a valid application that is stopped.
HALT	The controller has detected an application or system error and has ceased application execution.

**NOTE:** For further details on controller states, refer to the Operating Mode discussion in the Programming Guide for your particular controller.

## Dimensions

The following illustration describes the external dimensions of the controller:

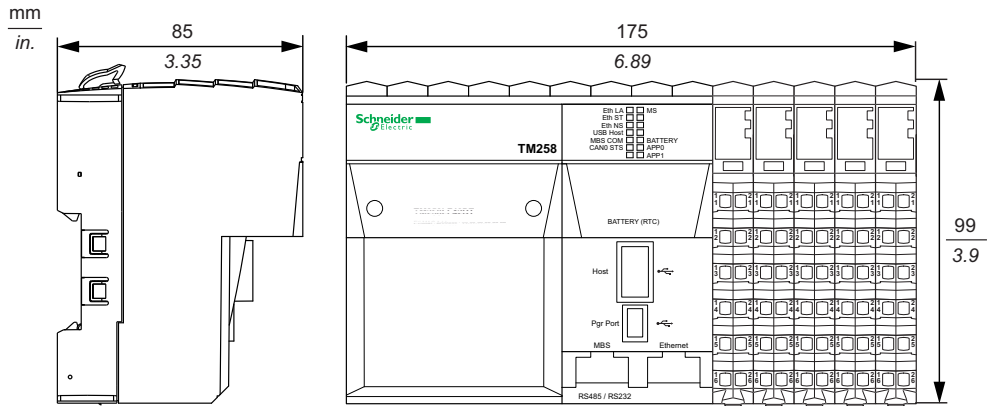

The following table describes the weight of the TM258LD42DT:

Weight	
TM258LD42DT	500 g (17.6 oz)

## Characteristics of the Controller Power Distribution Module

The Controller Power Distribution Module (CPDM) has three 24 Vdc power connections:

- Main power (**Ctrl**)
- Expert I/O power (**Exp.**)
- 24 Vdc I/O Power Segment power (**I/O**)

The state of these three power connections is indicated by a set of LEDs on the CPDM:

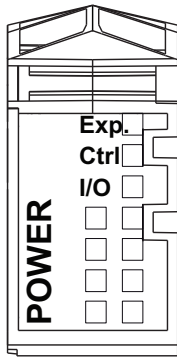

The following table describes the CPDM LED display:

LEDs	Color	Status	Description
Exp (Expert I/O power)	Green	On	24 Vdc applied
Ctrl (Main power)	Green	On	24 Vdc applied
I/O (24 Vdc I/O Power Segment power)	Green	On	24 Vdc applied

The Main power serves the TM5 power bus, the Serial Line port, the USB port, any PCI modules that may be installed, and power for the controller electronics.

The Expert I/O power serves the Expert I/O module inputs and outputs, the power for the embedded Encoder port, and power for the Expert I/O module electronics.

The 24 Vdc I/O power segment power serves the Regular I/O modules inputs and outputs, as well as providing power to the first segment of the 24 Vdc I/O Power segment for any optional I/O slices of the local configuration.

## CPDM Power Consumption Overview

The following table shows the power characteristics of the TM258LD42DT:

Rated voltage CPDM		24 Vdc	
Voltage range CPDM		20.4...28.8 Vdc	
Main power	Minimum current (no external loads)	0.3 A	
	Maximum current including the following loads:	0.8 A	
		Current for TM5 bus power when adding expansion modules	0...0.1 A
		Current for serial line when connected devices consume power	0...0.05 A
		Current for USB Host when connected devices consume power	0...0.1 A
	Inrush current	Time < 70 $\mu$ s	100 A max.
		70 ... 2000 $\mu$ s	3 A max.
Internal protection	No	see note 1	
Embedded Expert modules power	Minimum current (no external loads)	0.04 A	
	Maximum current including the following loads:	0.9 A	
		Current for Expert Inputs	0...0.1 A
		Current for Expert Outputs	0...0.8 A
	Inrush current	Time < 150 $\mu$ s	50 A max.
Internal protection	No	see note 1	
24 Vdc I/O power segment	Maximum current (depending on the modules on the segment)	10 A max.	
	Inrush current (depending on the modules on the segment)	Time < 500 $\mu$ s	25 A max.
	Internal protection	No	see note 1

<sup>1</sup> Add external fuse as specified in the wiring diagrams.

Refer to the chapter *Example 1: Current Consumed by a Local Configuration* for further details on power consumption.





---

# Chapter 5

## TM258LD42DT4L

---

### Introduction

This chapter describes the TM258LD42DT4L controller.

### What Is in This Chapter?

This chapter contains the following topics:

Topic	Page
General Description	50
Characteristics of the Controller Power Distribution Module	54

## General Description

### Overview

The following illustration shows the different components of the TM258LD42DT4L:

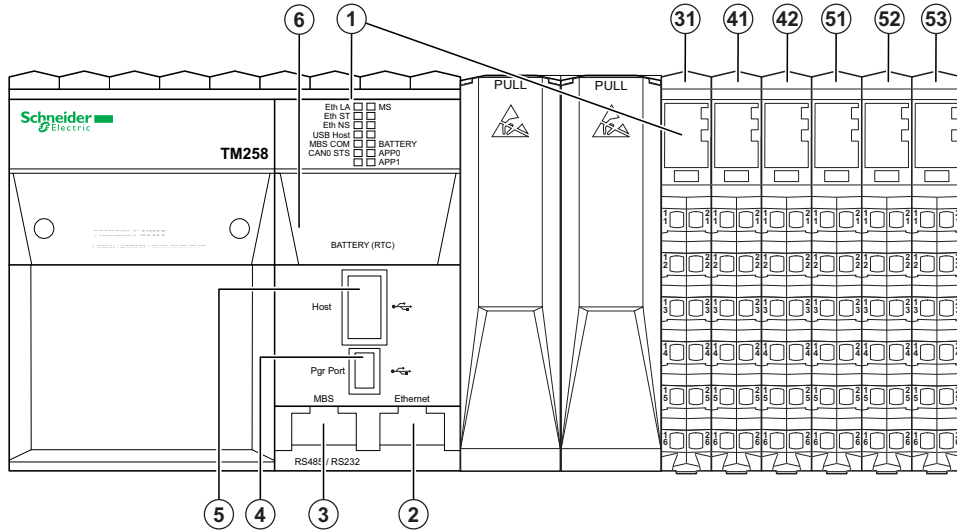

N°	Designation	Refer to
1	LED status	Status LEDs ( <a href="#">see page 51</a> )
2	Ethernet port / Type RJ45	Ethernet Port ( <a href="#">see page 92</a> )
3	Serial line / Type RJ45 (RS232 or RS485)	Serial Line Port ( <a href="#">see page 104</a> )
4	USB programming port / For terminal connection to a programming PC (EcoStruxure Machine Expert)	USB Programming Port ( <a href="#">see page 100</a> )
5	USB host / For memory key management	USB Host Port ( <a href="#">see page 102</a> )
6	Battery	RTC Battery ( <a href="#">see page 34</a> )
31	Controller Power Distribution Module / For connecting external power supplies	Controller Power Distribution Module ( <a href="#">see page 32</a> )
41	Embedded Expert I/O module / 5 fast inputs, 2 regular inputs, 2 fast outputs	Embedded Expert I/O ( <a href="#">see page 111</a> )
42		
51	Embedded Regular Input module / 12 digital inputs	Digital DI12DE ( <a href="#">see page 130</a> )
52	Embedded Regular Output module / 12 digital outputs	Digital DO12TE ( <a href="#">see page 134</a> )
53	Embedded Regular Input module / 4 analog inputs (12 bits)	Analog AI4LE ( <a href="#">see page 139</a> )

## Status LEDs

### General Description

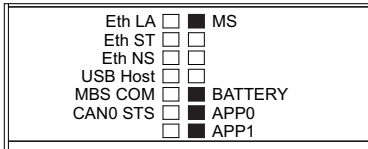

The following table describes the controller status LEDs:

Marking	Description	LED	
		Color	Description
MS	Module status	Green / Red	See MS status LED below
BATTERY	Battery status	Red	On when RTC battery needs to be replaced
APP0	Application LEDs	Green / Red	Managed by user application
APP1			

The following table describes the MS status LED:

Status LED	Controller State	Prg Port Communication	Application Execution
Flashing green / red	BOOTING	No	No
Flashing red	INVALID OS	Restricted	No
Single flash green	EMPTY	Yes	No
Green ON	RUNNING	Yes	Yes
3 flash green	RUNNING with Breakpoint	Yes	Restricted
Flashing green	STOPPED	Restricted	No
Single flash red	HALT	Yes	No
Rapid flashing red	REBOOT after a hardware error has been detected	Yes	No (Empty)
Red ON	HALT after system error detected	No	No
OFF	No power	No	No
Green / with single flash red	RUNNING with external error detected Or different Boot Project Or no Boot Project	Yes	Yes
Flashing green / with single flash red	STOPPED with external error detected	Restricted	No

**NOTE:** For further details on controller states, refer to the Operating Mode discussion in the Programming Guide for your particular controller.

For further details on the following LEDs:

- Eth LA, Eth ST and Eth NS, please refer to Ethernet Port - Status LEDs (*see page 94*).
- USB Host, please refer to USB Host Port - Status LED (*see page 103*).
- MBS COM, please refer to Serial Line Port - Status LED (*see page 107*).
- CAN0 STS, please refer to CAN Port - Status LED (*see page 99*).

**Identifying the logic controller**

The following illustration shows the LEDs on the front panel display:

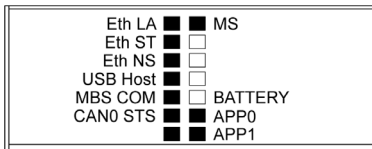

The LEDs flash when the logic controller is being identified. For more information, refer to EcoStruxure Machine Expert Programming Guide.

**Controller States**

The following table describes the controller states:

State	Description
BOOTING	The controller executes the boot firmware and its own internal self tests. It does not execute the application nor does it communicate. It then checks the checksum of the firmware and user application.
INVALID_OS	The Operating System is not valid. The controller can not execute an application. Communications are restricted.
EMPTY	The user application is not valid or a hardware error has been detected. The controller does not execute the application but it can communicate.
RUNNING	The controller executes the application.
STOPPED	The controller has a valid application that is stopped.
HALT	The controller has detected an application or system error and has ceased application execution.

**NOTE:** For further details on controller states, refer to the Operating Mode discussion in the Programming Guide for your particular controller.

**Dimensions**

The following illustration shows the external dimensions of the controller:

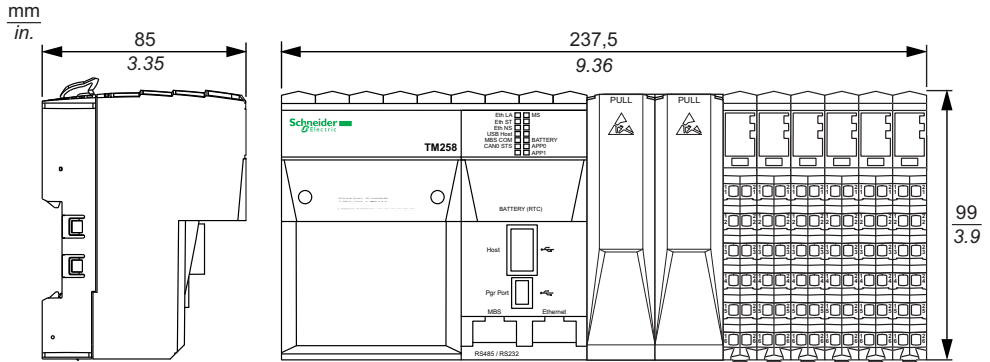

The following table describes the weight of the TM258LD42DT4L:

Weight	
TM258LD42DT4L	770 g (24.7 oz)

## Characteristics of the Controller Power Distribution Module

The Controller Power Distribution Module (CPDM) has three 24 Vdc power connections:

- Main power (**Ctrl**)
- Expert I/O power (**Exp.**)
- 24 Vdc I/O Power Segment power (**I/O**)

The state of these three power connections is indicated by a set of LEDs on the CPDM:

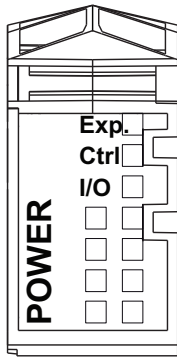

The following table describes the CPDM LED display:

LEDs	Color	Status	Description
Exp (Expert I/O power)	Green	On	24 Vdc applied
Ctrl(Main power)	Green	On	24 Vdc applied
I/O(24 Vdc I/O Power Segment power)	Green	On	24 Vdc applied

The Main power serves the TM5 power bus, the Serial Line port, the USB port, any PCI modules that may be installed, and power for the controller electronics.

The Expert I/O power serves the Expert I/O module inputs and outputs, the power for the embedded Encoder port, and power for the Expert I/O module electronics.

The 24 Vdc I/O power segment power serves the Regular I/O modules inputs and outputs, as well as providing power to the first segment of the 24 Vdc I/O Power segment for any optional I/O slices of the local configuration.

## CPDM Power Consumption Overview

The following table shows the power characteristics of the TM258LD42DT4L:

Rated voltage CPDM		24 Vdc	
Voltage range CPDM		20.4...28.8 Vdc	
Main power	Minimum current (no external loads)	0.3 A	
	Maximum current including the following loads:	1.2 A	
		Current for TM5 bus power when adding expansion modules	0...0.1 A
		Current for serial line when connected devices consume power	0...0.05 A
		Current for USB Host when connected devices consume power	0...0.1 A
		Current for optional PCI modules when connected devices consume power	Refer to your specific PCI module
	Inrush current	Time < 70 $\mu$ s	100 A max.
		70...2000 $\mu$ s	3 A max.
Internal protection	No	see note 1	
Embedded Expert modules power	Minimum current (no external loads)	0.04 A	
	Maximum current including the following loads:	0.9 A	
		Current for Expert Inputs	0...0.1 A
		Current for Expert Outputs	0...0.8 A
	Inrush current	Time < 150 $\mu$ s	50 A max.
	Internal protection	No	see note 1
24 Vdc I/O power segment	Maximum current (depending on the modules on the segment)	10 A max.	
	Inrush current (depending on the modules on the segment)	Time < 500 $\mu$ s	25 A max.
	Internal protection	No	see note 1

<sup>1</sup> Add external fuse as specified in the wiring diagrams.

Refer to the chapter *Example 1: Current Consumed by a Local Configuration* for further details on power consumption.





---

# Chapter 6

## TM258LF42DT

---

### Introduction

This chapter describes the TM258LF42DT controller.

### What Is in This Chapter?

This chapter contains the following topics:

Topic	Page
General Description	58
Characteristics of the Controller Power Distribution Module	62

## General Description

### Overview

The following illustration shows the different components of the TM258LF42DT:

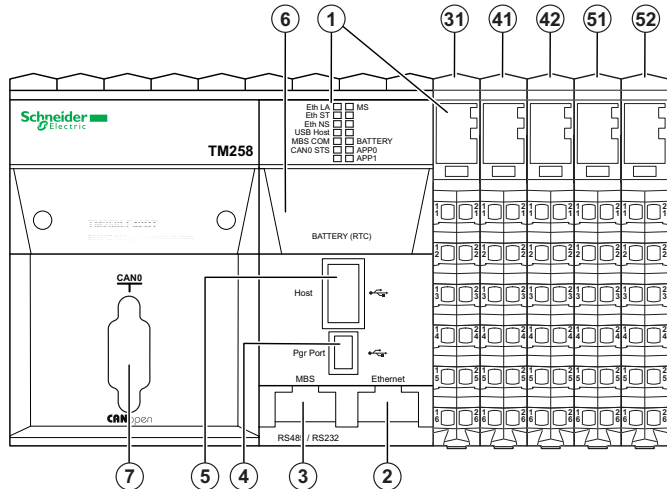

N°	Designation / Description	Refer to
1	LED status	Status LEDs ( <a href="#">see page 59</a> )
2	Ethernet port / Type RJ45	Ethernet Port ( <a href="#">see page 92</a> )
3	Serial line / Type RJ45 (RS232 or RS485)	Serial Line Port ( <a href="#">see page 104</a> )
4	USB programming port /For terminal connection to a programming PC (EcoStruxure Machine Expert)	USB Programming Port ( <a href="#">see page 100</a> )
5	USB host / For memory key management	USB Host Port ( <a href="#">see page 102</a> )
6	Battery	RTC Battery ( <a href="#">see page 34</a> )
7	CAN 0 port / Male D-Sub 9 CANopen Master	CAN Port ( <a href="#">see page 96</a> )
31	Controller Power Distribution Module / For connecting external power supplies	Controller Power Distribution Module ( <a href="#">see page 32</a> )
41	Embedded Expert I/O modules / 5 fast inputs, 2 regular inputs, 2 fast outputs	Embedded Expert I/O ( <a href="#">see page 111</a> )
42		
51	Embedded Regular Input module / 12 digital inputs	Digital DI12DE ( <a href="#">see page 130</a> )
52	Embedded Regular Output module / 12 digital outputs	Digital DO12TE ( <a href="#">see page 134</a> )

Status LEDs

General Description

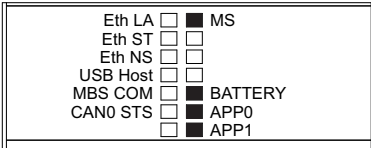

The following table describes the controller status LEDs:

Marking	Description	LED	
		Color	Description
MS	Module status	Green / Red	See MS status LED below
BATTERY	Battery status	Red	On when RTC battery needs to be replaced
APP0	Application LEDs	Green / Red	Managed by user application
APP1			

The following table describes the MS status LED:

Status LED	Controller State	Prg Port Communication	Application Execution
Flashing green / red	BOOTING	No	No
Flashing red	INVALID OS	Restricted	No
Single flash green	EMPTY	Yes	No
Green ON	RUNNING	Yes	Yes
3 flash green	RUNNING with Breakpoint	Yes	Restricted
Flashing green	STOPPED	Restricted	No
Single flash red	HALT	Yes	No
Rapid flashing red	REBOOT after a hardware error has been detected	Yes	No (Empty)
Red ON	HALT after system error detected	No	No
OFF	No power	No	No
Green / with single flash red	RUNNING with external error detected Or different Boot Project Or no Boot Project	Yes	Yes
Flashing green / with single flash red	STOPPED with external error detected	Restricted	No

**NOTE:** For further details on controller states, refer to the Operating Mode discussion in the Programming Guide for your particular controller.

For further details on the following LEDs:

- Eth LA, Eth ST and Eth NS, please refer to Ethernet Port - Status LEDs (*see page 94*).
- USB Host, please refer to USB Host Port - Status LED (*see page 103*).
- MBS COM, please refer to Serial Line Port - Status LED (*see page 107*).
- CAN0 STS, please refer to CAN Port - Status LED (*see page 99*).

**Identifying the logic controller**

The following illustration shows the LEDs on the front panel display:

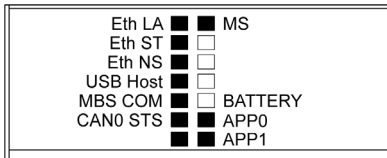

The LEDs flash when the logic controller is being identified. For more information, refer to EcoStruxure Machine Expert Programming Guide.

**Controller States**

The following table describes the controller states:

State	Description
BOOTING	The controller executes the boot firmware and its own internal self tests. It does not execute the application nor does it communicate. It then checks the checksum of the firmware and user application.
INVALID_OS	The Operating System is not valid. The controller can not execute an application. Communications are restricted.
EMPTY	The user application is not valid or a hardware error has been detected. The controller does not execute the application but it can communicate.
RUNNING	The controller executes the application.
STOPPED	The controller has a valid application that is stopped.
HALT	The controller has detected an application or system error and has ceased application execution.

**NOTE:** For further details on controller states, refer to the Operating Mode discussion in the Programming Guide for your particular controller.

### Dimensions

The following illustration shows the external dimensions of the controller:

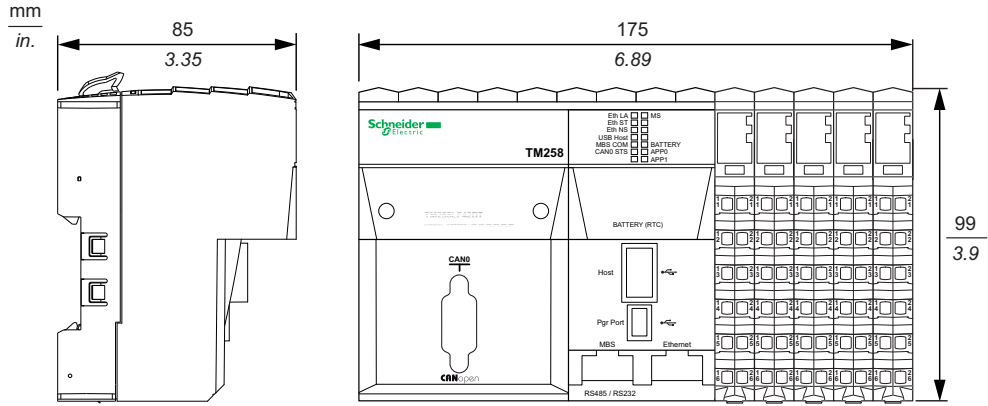

The following table describes the weight of the TM258LF42DT:

Weight	
TM258LF42DT	550 g (19.4 oz)

## Characteristics of the Controller Power Distribution Module

The Controller Power Distribution Module (CPDM) has three 24 Vdc power connections:

- Main power (**Ctrl**)
- Expert I/O power (**Exp.**)
- 24 Vdc I/O Power Segment power (**I/O**)

The state of these three power connections is indicated by a set of LEDs on the CPDM:

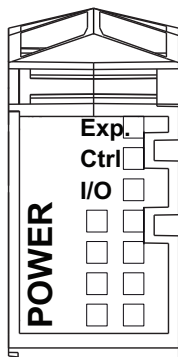

The following table describes the CPDM LED display:

LEDs	Color	Status	Description
Exp (Expert I/O power)	Green	On	24 Vdc applied
Ctrl (Main power)	Green	On	24 Vdc applied
I/O (24 Vdc I/O Power Segment power)	Green	On	24 Vdc applied

The Main power serves the TM5 power bus, the Serial Line port, the USB port, any PCI modules that may be installed, and power for the controller electronics.

The Expert I/O power serves the Expert I/O module inputs and outputs, the power for the embedded Encoder port, and power for the Expert I/O module electronics.

The 24 Vdc I/O power segment power serves the Regular I/O modules inputs and outputs, as well as providing power to the first segment of the 24 Vdc I/O Power segment for any optional I/O slices of the local configuration.

## CPDM Power Consumption Overview

The following table shows the power characteristics of the TM258LF42DT:

Rated voltage CPDM		24 Vdc	
Voltage range CPDM		20.4...28.8 Vdc	
Main power	Minimum current (no external loads)	0.3 A	
	Maximum current including the following loads:	0.8 A	
		Current for TM5 bus power when adding expansion modules	0...0.1 A
		Current for serial line when connected devices consume power	0...0.05 A
		Current for USB Host when connected devices consume power	0...0.1 A
	Inrush current	Time < 70 $\mu$ s	100 A max.
		70...2000 $\mu$ s	3 A max.
Internal protection	No	see note 1	
Embedded Expert modules power	Minimum current (no external loads)	0.04 A	
	Maximum current including the following loads:	0.9 A	
		Current for Expert Inputs	0...0.1 A
		Current for Expert Outputs	0...0.8 A
	Inrush current	Time < 150 $\mu$ s	50 A max.
	Internal protection	No	see note 1
24 Vdc I/O power segment	Maximum current (depending on the modules on the segment)	10 A max.	
	Inrush current (depending on the modules on the segment)	Time < 500 $\mu$ s	25 A max.
	Internal protection	No	see note 1

<sup>1</sup> Add external fuse as specified in the wiring diagrams.

Refer to the chapter *Example 1: Current Consumed by a Local Configuration* for further details on power consumption.





---

# Chapter 7

## TM258LF42DT4L

---

### Introduction

This chapter describes the TM258LF42DT4L controller.

### What Is in This Chapter?

This chapter contains the following topics:

Topic	Page
General Description	66
Characteristics of the Controller Power Distribution Module	70

## General Description

### Overview

The following illustration shows the different components of the TM258LF42DT4L:

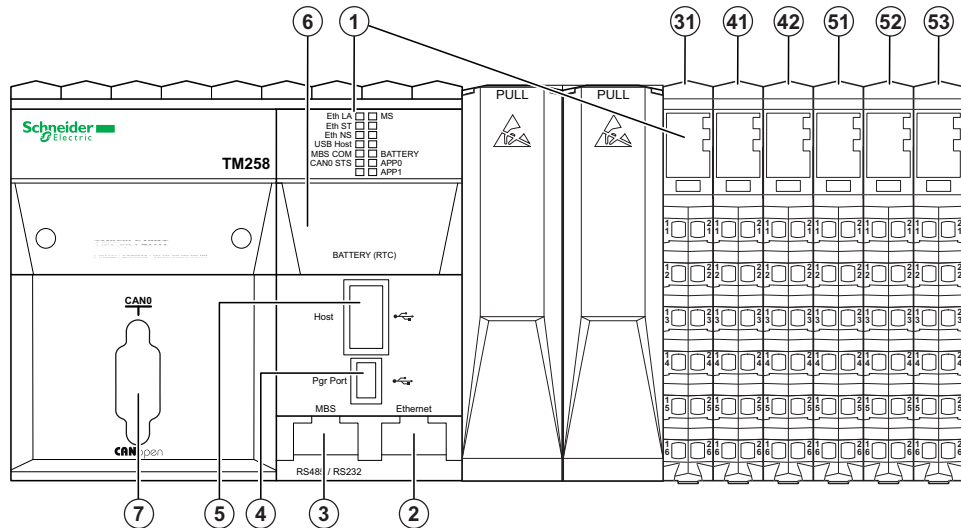

N°	Designation / Description	Refer to
1	LED status	Status LEDs ( <a href="#">see page 67</a> )
2	Ethernet port / Type RJ45	Ethernet Port ( <a href="#">see page 92</a> )
3	Serial line / Type RJ45 (RS232 or RS485)	Serial Line Port ( <a href="#">see page 104</a> )
4	USB programming port /For terminal connection to a programming PC (EcoStruxure Machine Expert)	USB Programming Port ( <a href="#">see page 100</a> )
5	USB host / For memory key management	USB Host Port ( <a href="#">see page 102</a> )
6	Battery	RTC Battery ( <a href="#">see page 34</a> )
7	CAN 0 Port / Male Sub-D 9 CANopen Master	CAN Port ( <a href="#">see page 96</a> )
31	Controller Power Distribution Module / For connecting external power supplies	Controller Power Distribution Module ( <a href="#">see page 32</a> )
41	Embedded Expert I/O modules / 5 fast inputs, 2 regular inputs, 2 fast outputs	Embedded Expert I/O ( <a href="#">see page 111</a> )
42		
51	Embedded Regular Input module / 12 digital inputs	Digital DI12DE ( <a href="#">see page 130</a> )
52	Embedded Regular Output module / 12 digital outputs	Digital DO12TE ( <a href="#">see page 134</a> )
53	Embedded Regular Input module / 4 analog inputs (12-bits)	Analog AI4LE ( <a href="#">see page 139</a> )

## Status LEDs

### General Description

Eth LA	<input type="checkbox"/>	<input checked="" type="checkbox"/>	MS
Eth ST	<input type="checkbox"/>	<input type="checkbox"/>	
Eth NS	<input type="checkbox"/>	<input type="checkbox"/>	
USB Host	<input type="checkbox"/>	<input type="checkbox"/>	
MBS COM	<input type="checkbox"/>	<input checked="" type="checkbox"/>	BATTERY
CAN0 STS	<input type="checkbox"/>	<input checked="" type="checkbox"/>	APP0
	<input type="checkbox"/>	<input checked="" type="checkbox"/>	APP1

The following table describes the controller status LEDs:

Marking	Description	LED	
		Color	Description
MS	Module status	Green / Red	See MS status LED below
BATTERY	Battery status	Red	On when RTC battery needs to be replaced
APP0	Application LEDs	Green / Red	Managed by user application
APP1			

The following table describes the MS status LED:

Status LED	Controller State	Prg Port Communication	Application Execution
Flashing green / red	BOOTING	No	No
Flashing red	INVALID OS	Restricted	No
Single flash green	EMPTY	Yes	No
Green ON	RUNNING	Yes	Yes
3 flash green	RUNNING with Breakpoint	Yes	Restricted
Flashing green	STOPPED	Restricted	No
Single flash red	HALT	Yes	No
Rapid flashing red	REBOOT after a hardware error has been detected	Yes	No (Empty)
Red ON	HALT after system error detected	No	No
OFF	No power	No	No
Green / with single flash red	RUNNING with external error detected Or different Boot Project Or no Boot Project	Yes	Yes
Flashing green / with single flash red	STOPPED with external error detected	Restricted	No

**NOTE:** For further details on controller states, refer to the Operating Mode discussion in the Programming Guide for your particular controller.

For further details on the following LEDs:

- Eth LA, Eth ST and Eth NS, please refer to Ethernet Port - Status LEDs (*see page 94*).
- USB Host, please refer to USB Host Port - Status LED (*see page 103*).
- MBS COM, please refer to Serial Line Port - Status LED (*see page 107*).
- CAN0 STS, please refer to CAN Port - Status LED (*see page 99*).

**Identifying the logic controller**

The following illustration shows the LEDs on the front panel display:

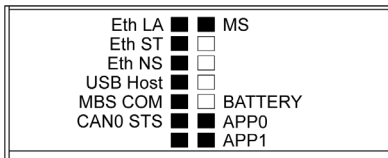

The LEDs flash when the logic controller is being identified. For more information, refer to EcoStruxure Machine Expert Programming Guide.

**Controller States**

The following table describes the controller states:

State	Description
BOOTING	The controller executes the boot firmware and its own internal self tests. It does not execute the application nor does it communicate. It then checks the checksum of the firmware and user application.
INVALID_OS	The Operating System is not valid. The controller can not execute an application. Communications are restricted.
EMPTY	The user application is not valid or a hardware error has been detected. The controller does not execute the application but it can communicate.
RUNNING	The controller executes the application.
STOPPED	The controller has a valid application that is stopped.
HALT	The controller has detected an application or system error and has ceased application execution.

**NOTE:** For further details on controller states, refer to the Operating Mode discussion in the Programming Guide for your particular controller.

## Dimensions

The following illustration shows the external dimensions of the controller:

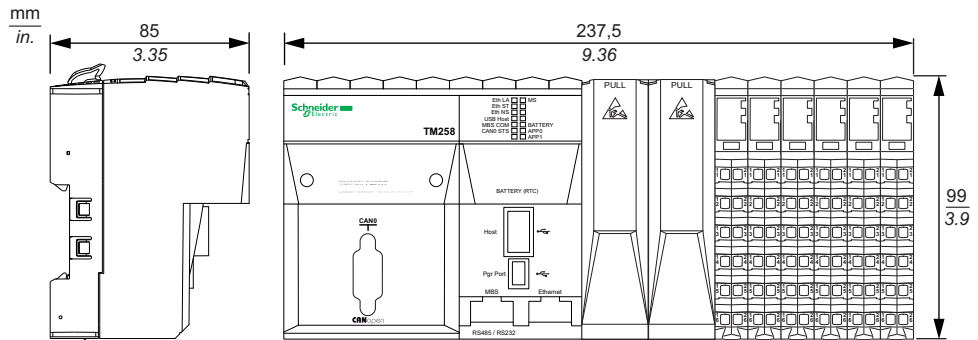

The following table describes the weight of the TM258LF42DT4L:

Weight	
TM258LF42DT4L	770 g (24.7 oz)

## Characteristics of the Controller Power Distribution Module

The Controller Power Distribution Module (CPDM) has three 24 Vdc power connections:

- Main power (**Ctrl**)
- Expert I/O power (**Exp.**)
- 24 Vdc I/O Power Segment power (**I/O**)

The state of these three power connections is indicated by a set of LEDs on the CPDM:

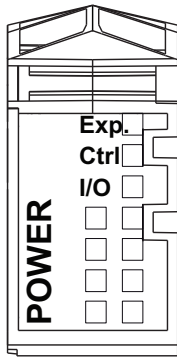

The following table describes the CPDM LED display:

LEDs	Color	Status	Description
Exp (Expert I/O power)	Green	On	24 Vdc applied
Ctrl (Main power)	Green	On	24 Vdc applied
I/O (24 Vdc I/O Power Segment power)	Green	On	24 Vdc applied

The Main power serves the TM5 power bus, the Serial Line port, the USB port, any PCI modules that may be installed, and power for the controller electronics.

The Expert I/O power serves the Expert I/O module inputs and outputs, the power for the embedded Encoder port, and power for the Expert I/O module electronics.

The 24 Vdc I/O power segment power serves the Regular I/O modules inputs and outputs, as well as providing power to the first segment of the 24 Vdc I/O Power segment for any optional I/O slices of the local configuration.

## CPDM Power Consumption Overview

The following table shows the power characteristics of the TM258LF42DT4L:

Rated voltage CPDM		24 Vdc	
Voltage range CPDM		20.4...28.8 Vdc	
Main power	Minimum current (no external loads)	0.3 A	
	Maximum current including the following loads:	1.2 A	
		Current for TM5 bus power when adding expansion modules	0...0.1 A
		Current for serial line when connected devices consume power	0...0.05 A
		Current for USB Host when connected devices consume power	0...0.1 A
		Current for optional PCI modules when connected devices consume power	Refer to your specific PCI module
	Inrush current	Time < 70 $\mu$ s	100 A max.
		70...2000 $\mu$ s	3 A max.
Internal protection	No	see note 1	
Embedded Expert modules power	Minimum current (no external loads)	0.04 A	
	Maximum current including the following loads:	0.9 A	
		Current for Expert Inputs	0...0.1 A
		Current for Expert Outputs	0...0.8 A
	Inrush current	Time < 150 $\mu$ s	50 A max.
	Internal protection	No	see note 1
24 Vdc I/O power segment	Maximum current (depending on the modules on the segment)	10 A max.	
	Inrush current (depending on the modules on the segment)	Time < 500 $\mu$ s	25 A max.
	Internal protection	No	see note 1

<sup>1</sup> Add external fuse as specified in the wiring diagrams.

Refer to the chapter *Example 1: Current Consumed by a Local Configuration* for further details on power consumption.





---

# Chapter 8

## TM258LF66DT4L

---

### Introduction

This chapter describes the TM258LF66DT4L controller.

### What Is in This Chapter?

This chapter contains the following topics:

Topic	Page
General Description	74
Characteristics of the Controller Power Distribution Module	78

## General Description

### Overview

The following illustration shows the different components of the TM258LF66DT4L:

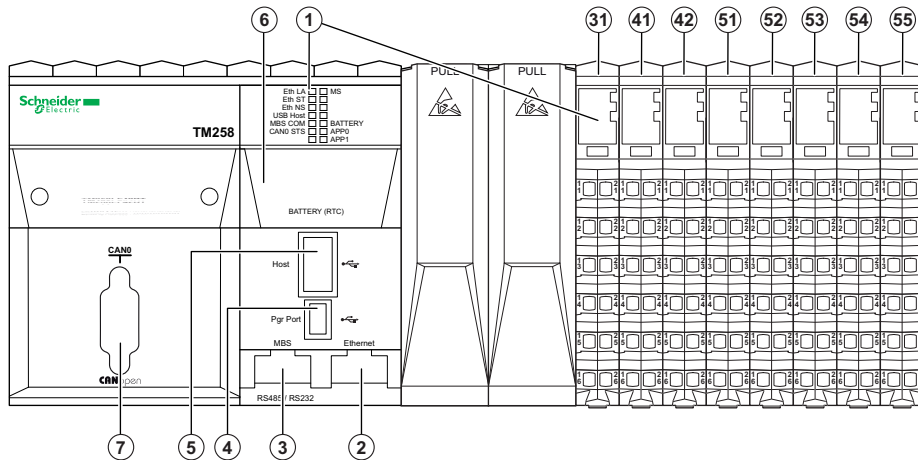

N°	Designation / Description	Refer to
1	LED status	Status LEDs ( <a href="#">see page 75</a> )
2	Ethernet port / Type RJ45	Ethernet Port ( <a href="#">see page 92</a> )
3	Serial line / Type RJ45 (RS232 or RS485)	Serial Line Port ( <a href="#">see page 104</a> )
4	USB programming port / For terminal connection to a programming PC (EcoStruxure Machine Expert)	USB Programming Port ( <a href="#">see page 100</a> )
5	USB host / For memory key management	USB Host Port ( <a href="#">see page 102</a> )
6	Battery	RTC Battery ( <a href="#">see page 34</a> )
7	CAN 0 Port / Male Sub-D 9 CANopen Master	CAN Port ( <a href="#">see page 96</a> )
31	Controller Power distribution Module / For connecting external power supplies	Controller Power Distribution Module ( <a href="#">see page 32</a> )
41	Embedded Expert I/O modules / 5 fast inputs, 2 regular inputs, 2 fast outputs	Embedded Expert I/O ( <a href="#">see page 111</a> )
42		
51	Embedded Regular Input modules / 12 digital inputs	Digital DI12DE ( <a href="#">see page 130</a> )
52		
53	Embedded Regular Output modules / 12 digital outputs	Digital DO12TE ( <a href="#">see page 134</a> )
54		
55	Embedded Regular Input module / 4 analog inputs (12-bits)	Analog AI4LE ( <a href="#">see page 139</a> )

## Status LEDs

### General Description

Eth LA	<input type="checkbox"/>	<input checked="" type="checkbox"/>	MS
Eth ST	<input type="checkbox"/>	<input type="checkbox"/>	
Eth NS	<input type="checkbox"/>	<input type="checkbox"/>	
USB Host	<input type="checkbox"/>	<input type="checkbox"/>	
MBS COM	<input type="checkbox"/>	<input checked="" type="checkbox"/>	BATTERY
CAN0 STS	<input type="checkbox"/>	<input checked="" type="checkbox"/>	APP0
	<input type="checkbox"/>	<input checked="" type="checkbox"/>	APP1

The following table describes the controller status LEDs:

Marking	Description	LED	
		Color	Description
MS	Module status	Green / Red	See MS status LED below
BATTERY	Battery status	Red	On when RTC battery needs to be replaced
APP0	Application LEDs	Green / Red	Managed by user application
APP1			

The following table describes the MS status LED:

Status LED	Controller State	Prg Port Communication	Application Execution
Flashing green / red	BOOTING	No	No
Flashing red	INVALID OS	Restricted	No
Single flash green	EMPTY	Yes	No
Green ON	RUNNING	Yes	Yes
3 flash green	RUNNING with Breakpoint	Yes	Restricted
Flashing green	STOPPED	Restricted	No
Single flash red	HALT	Yes	No
Rapid flashing red	REBOOT after a hardware error has been detected	Yes	No (Empty)
Red ON	HALT after system error detected	No	No
OFF	No power	No	No
Green / with single flash red	RUNNING with external error detected Or different Boot Project Or no Boot Project	Yes	Yes
Flashing green / with single flash red	STOPPED with external error detected	Restricted	No

**NOTE:** For further details on controller states, refer to the Operating Mode discussion in the Programming Guide for your particular controller.

For further details on the following LEDs:

- Eth LA, Eth ST and Eth NS, please refer to Ethernet Port - Status LEDs (*see page 94*).
- USB Host, please refer to USB Host Port - Status LED (*see page 103*).
- MBS COM, please refer to Serial Line Port - Status LED (*see page 107*).
- CAN0 STS, please refer to CAN Port - Status LED (*see page 99*).

**Identifying the logic controller**

The following illustration shows the LEDs on the front panel display:

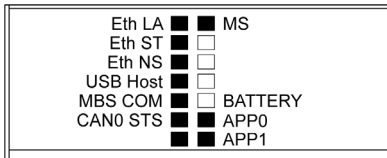

The LEDs flash when the logic controller is being identified. For more information, refer to EcoStruxure Machine Expert Programming Guide.

**Controller States**

The following table describes the controller states:

State	Description
BOOTING	The controller executes the boot firmware and its own internal self tests. It does not execute the application nor does it communicate. It then checks the checksum of the firmware and user application.
INVALID_OS	The Operating System is not valid. The controller can not execute an application. Communications are restricted.
EMPTY	The user application is not valid or a hardware error has been detected. The controller does not execute the application but it can communicate.
RUNNING	The controller executes the application.
STOPPED	The controller has a valid application that is stopped.
HALT	The controller has detected an application or system error and has ceased application execution.

**NOTE:** For further details on controller states, refer to the Operating Mode discussion in the Programming Guide for your particular controller.

## Dimensions

The following illustration shows the external dimensions of the controller:

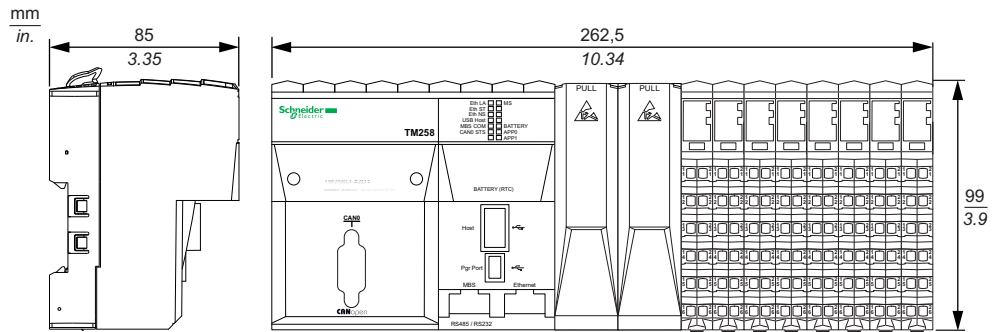

The following table describes the weight of the TM258LF66DT4L:

Weight	
TM258LF66DT4L	800 g (28.2 oz)

## Characteristics of the Controller Power Distribution Module

The Controller Power Distribution Module (CPDM) has three 24 Vdc power connections:

- Main power (**Ctrl**)
- Expert I/O power (**Exp.**)
- 24 Vdc I/O Power Segment power (**I/O**)

The state of these three power connections is indicated by a set of LEDs on the CPDM:

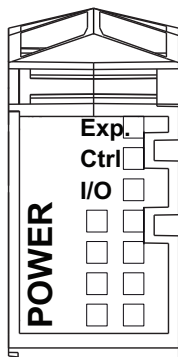

The following table describes the CPDM LED display:

LEDs	Color	Status	Description
Exp (Expert I/O power)	Green	On	24 Vdc applied
Ctrl (Main power)	Green	On	24 Vdc applied
I/O (24 Vdc I/O Power Segment power)	Green	On	24 Vdc applied

The Main power serves the TM5 power bus, the Serial Line port, the USB port, any PCI modules that may be installed, and power for the controller electronics.

The Expert I/O power serves the Expert I/O module inputs and outputs, the power for the embedded Encoder port, and power for the Expert I/O module electronics.

The 24 Vdc I/O power segment power serves the Regular I/O modules inputs and outputs, as well as providing power to the first segment of the 24 Vdc I/O Power segment for any optional I/O slices of the local configuration.

## CPDM Power Consumption Overview

The following table shows the power characteristics of the TM258LF66DT4L:

Rated voltage CPDM		24 Vdc	
Voltage range CPDM		20.4...28.8 Vdc	
Main power	Minimum current (no external loads)	0.3 A	
	Maximum current including the following loads:	1.2 A	
		Current for TM5 bus power when adding expansion modules	0...0.1 A
		Current for serial line when connected devices consume power	0...0.05 A
		Current for USB Host when connected devices consume power	0...0.1 A
		Current for optional PCI modules when connected devices consume power	Refer to your specific PCI module
	Inrush current	Time < 70 $\mu$ s	100 A max.
		70...2000 $\mu$ s	3 A max.
Internal protection	No	see note 1	
Embedded Expert modules power	Minimum current (no external loads)	0.04 A	
	Maximum current including the following loads:	0.9 A	
		Current for Expert Inputs	0...0.1 A
		Current for Expert Outputs	0...0.8 A
	Inrush current	Time < 150 $\mu$ s	50 A max.
	Internal protection	No	see note 1
24 Vdc I/O power segment	Maximum current (depending on the modules on the segment)	10 A max.	
	Inrush current (depending on the modules on the segment)	Time < 500 $\mu$ s	25 A max.
	Internal protection	No	see note 1

<sup>1</sup> Add external fuse as specified in the wiring diagrams.

Refer to the chapter *Example 1: Current Consumed by a Local Configuration* for further details on power consumption.





---

# Chapter 9

## TM258LF42DR

---

### Introduction

This chapter describes the TM258LF42DR controller.

### What Is in This Chapter?

This chapter contains the following topics:

Topic	Page
General Description	82
Characteristics of the Controller Power Distribution Module	86

## General Description

### Overview

The following illustration shows the different components of the TM258LF42DR:

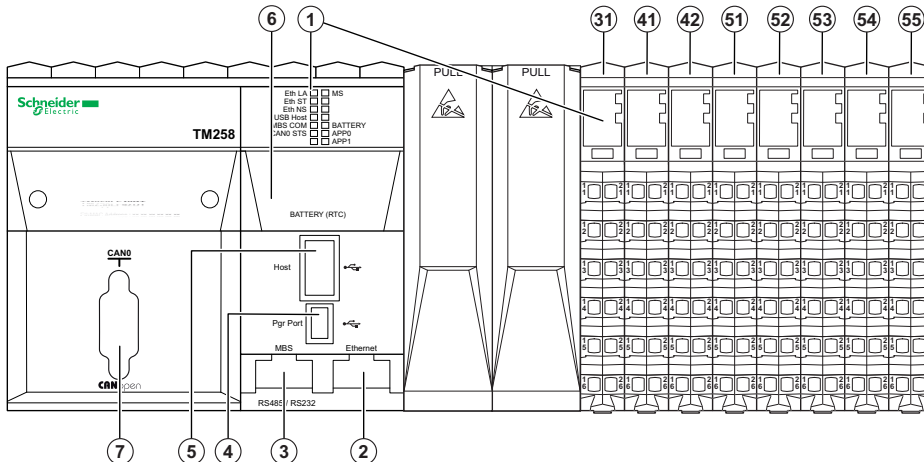

N°	Designation / Description	Refer to
1	LED status	Status LEDs ( <i>see page 83</i> )
2	Ethernet port / Type RJ45	Ethernet Port ( <i>see page 92</i> )
3	RS485 port / Type RJ45 (RS232 or RS485)	Serial Line Port ( <i>see page 104</i> )
4	USB programming port / For terminal connection to a programming PC (EcoStruxure Machine Expert)	USB Programming Port ( <i>see page 100</i> )
5	USB host / For memory key management	USB Host Port ( <i>see page 102</i> )
6	Battery	RTC Battery ( <i>see page 34</i> )
7	CAN 0 Port / Male Sub-D 9 CANopen Master	CAN Port ( <i>see page 96</i> )
31	Controller Power Distribution Module / For connecting external power supplies	Controller Power Distribution Module ( <i>see page 32</i> )
41		
42	Embedded Expert I/O modules / 5 fast inputs, 2 regular inputs, 2 fast outputs	Embedded Expert I/O ( <i>see page 111</i> )
51		
52	Embedded Regular Output modules / 6 relay outputs	Relay DO6RE ( <i>see page 143</i> )
53		
54		

## Status LEDs

### General Description

Eth LA	<input type="checkbox"/>	<input checked="" type="checkbox"/>	MS
Eth ST	<input type="checkbox"/>	<input type="checkbox"/>	
Eth NS	<input type="checkbox"/>	<input type="checkbox"/>	
USB Host	<input type="checkbox"/>	<input type="checkbox"/>	
MBS COM	<input type="checkbox"/>	<input checked="" type="checkbox"/>	BATTERY
CAN0 STS	<input type="checkbox"/>	<input checked="" type="checkbox"/>	APP0
	<input type="checkbox"/>	<input checked="" type="checkbox"/>	APP1

The following table describes the controller status LEDs:

Marking	Description	LED	
		Color	Description
MS	Module status	Green / Red	See MS status LED below
BATTERY	Battery status	Red	On when RTC battery needs to be replaced
APP0	Application LEDs	Green / Red	Managed by user application
APP1			

The following table describes the MS status LED:

Status LED	Controller State	Prg Port Communication	Application Execution
Flashing green / red	BOOTING	No	No
Flashing red	INVALID OS	Restricted	No
Single flash green	EMPTY	Yes	No
Green ON	RUNNING	Yes	Yes
3 flash green	RUNNING with Breakpoint	Yes	Restricted
Flashing green	STOPPED	Restricted	No
Single flash red	HALT	Yes	No
Rapid flashing red	REBOOT after a hardware error has been detected	Yes	No (Empty)
Red ON	HALT after system error detected	No	No
OFF	No power	No	No
Green / with single flash red	RUNNING with external error detected Or different Boot Project Or no Boot Project	Yes	Yes
Flashing green / with single flash red	STOPPED with external error detected	Restricted	No

**NOTE:** For further details on controller states, refer to the Operating Mode discussion in the Programming Guide for your particular controller.

For further details on the following LEDs:

- Eth LA, Eth ST and Eth NS, please refer to Ethernet Port - Status LEDs (*see page 94*).
- USB Host, please refer to USB Host Port - Status LED (*see page 103*).
- MBS COM, please refer to Serial Line Port - Status LED (*see page 107*).
- CAN0 STS, please refer to CAN Port - Status LED (*see page 99*).

**Identifying the logic controller**

The following illustration shows the LEDs on the front panel display:

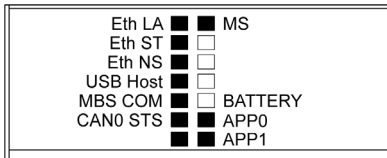

The LEDs flash when the logic controller is being identified. For more information, refer to EcoStruxure Machine Expert Programming Guide.

**Controller States**

The following table describes the controller states:

State	Description
BOOTING	The controller executes the boot firmware and its own internal self tests. It does not execute the application nor does it communicate. It then checks the checksum of the firmware and user application.
INVALID_OS	The Operating System is not valid. The controller can not execute an application. Communications are restricted.
EMPTY	The user application is not valid or a hardware error has been detected. The controller does not execute the application but it can communicate.
RUNNING	The controller executes the application.
STOPPED	The controller has a valid application that is stopped.
HALT	The controller has detected an application or system error and has ceased application execution.

**NOTE:** For further details on controller states, refer to the Operating Mode discussion in the Programming Guide for your particular controller.

## Dimensions

The following illustration shows the external dimensions of the controller:

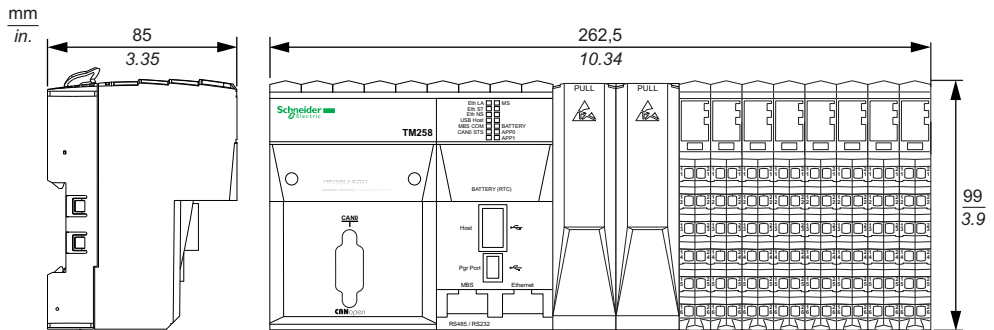

The following table describes the weight of the TM258LF42DR:

Weight	
TM258LF42DR	800 g (28.2 oz)

## Characteristics of the Controller Power Distribution Module

The Controller Power Distribution Module (CPDM) has three 24 Vdc power connections:

- Main power (**Cutler**)
- Expert I/O power (**Expo.**)
- 24 Vdc I/O Power Segment power (**I/O**)

The state of these three power connections is indicated by a set of LEDs on the CPDM:

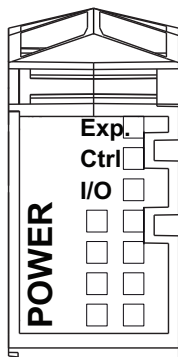

The following table describes the CPDM LED display:

LEDs	Color	Status	Description
Expo (Expert I/O power)	Green	On	24 Vdc applied
Ctrl (Main power)	Green	On	24 Vdc applied
I/O (24 Vdc I/O Power Segment power)	Green	On	24 Vdc applied

The Main power serves the TM5 power bus, the Serial Line port, the USB port, any PCI modules that may be installed, and power for the controller electronics.

The Expert I/O power serves the Expert I/O module inputs and outputs, the power for the embedded Encoder port, and power for the Expert I/O module electronics.

The 24 Vdc I/O power segment power serves the Regular I/O modules inputs and outputs, as well as providing power to the first segment of the 24 Vdc I/O Power segment for any optional I/O slices of the local configuration.

## CPDM Power Consumption Overview

The following table shows the power characteristics of the TM258LF42DR:

Rated voltage CPDM		24 Vdc	
Voltage range CPDM		20.4...28.8 Vdc	
Main power	Minimum current (no external loads)		0.3 A
	Maximum current including the following loads:		1.3 A
		Current for TM5 bus power when adding expansion modules	0...0.1 A
		Current for serial line when connected devices consume power	0...0.05 A
		Current for USB Host when connected devices consume power	0...0.1 A
		Current for optional PCI modules when connected devices consume power	Refer to your specific PCI module
	Inrush current	Time < 70 $\mu$ s	100 A max.
		70...2000 $\mu$ s	3 A max.
Internal protection	No	see note 1	
Embedded Expert modules power	Minimum current (no external loads)		0.04 A
	Maximum current including the following loads:		0.9 A
		Current for Expert Inputs	0...0.1 A
		Current for Expert Outputs	0...0.8 A
	Inrush current	Time < 150 $\mu$ s	50 A max.
	Internal protection	No	see note 1
24 Vdc I/O power segment	Maximum current (depending on the modules on the segment)		10 A max.
	Inrush current (depending on the modules on the segment)	Time < 500 $\mu$ s	25 A max.
	Internal protection	No	see note 1

<sup>1</sup> Add external fuse as specified in the wiring diagrams.

Refer to the chapter *Example 1: Current Consumed by a Local Configuration* for further details on power consumption.





# Chapter 10

## Power Distribution Wiring Diagram

### Wiring Diagram for External Power Supplies

#### Wiring Diagram

**NOTE:** Connect the 0 Vdc power circuits together and to the functional ground (FE) of your system to meet the EMC requirements.

⚠ **DANGER**

HAZARD OF ELECTRIC SHOCK, EXPLOSION, OVERHEATING AND FIRE

- Do not connect the modules directly to line voltage.
- Use only isolating PELV systems according to IEC 61140 to supply power to the modules.
- Connect the 0 Vdc of the external power supplies to FE (Functional Earth/ground).

Failure to follow these instructions will result in death or serious injury.

The following illustration shows the wiring diagram of the Controller Power Distribution Module (CPDM):

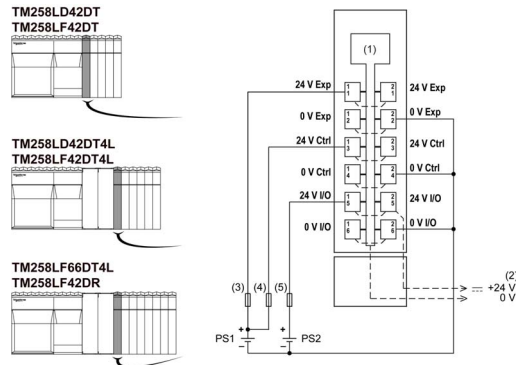

- 1 Internal electronics
  - 2 24 Vdc I/O power segment integrated into the bus bases
  - 3 External fuse, Type T slow-blow, 3 A 250 V
  - 4 External fuse, Type T slow-blow, 2 A 250 V
  - 5 External fuse, Type T slow-blow, 10 A max., 250 V
- PS1/PS2** External isolated power supply 24 Vdc  
**Exp** Embedded expert I/O power  
**Ctrl** Main power  
**I/O** I/O Power Segment power

**NOTE:** The assigned fuse values have been specified for the maximum current characteristics of the controller or expansion I/O and associated commons. You may have other considerations that are applicable based on the unique types of input and output devices you connect, or conformance to local, national or applicable certification regulations and standards, and you should size your fuses accordingly.

## DANGER

### **FIRE HAZARD**

- Use only the correct wire sizes for the maximum current capacity of the I/O channels and power supplies.
- For relay output (2 A) wiring, use conductors of at least 0.5 mm<sup>2</sup> (AWG 20) with a temperature rating of at least 80 °C (176 °F).
- For common conductors of relay output wiring (7 A), or relay output wiring greater than 2 A, use conductors of at least 1.0 mm<sup>2</sup> (AWG 16) with a temperature rating of at least 80 °C (176 °F).

**Failure to follow these instructions will result in death or serious injury.**

---

# Chapter 11

## Integrated Communication Ports

---

### What Is in This Chapter?

This chapter contains the following topics:

Topic	Page
Ethernet Port	92
CAN Port	96
USB Programming Port	100
USB Host Port	102
Serial Line Port	104

## Ethernet Port

### Overview

The following illustration shows the location of the Ethernet port of the controller:

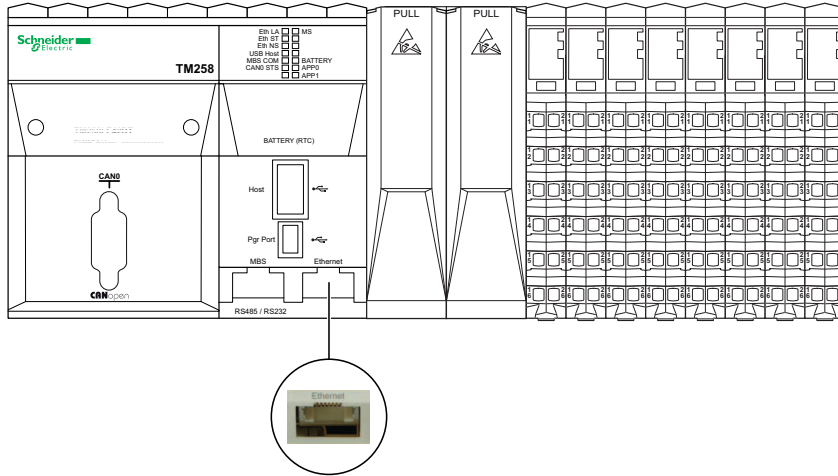

### Characteristics

The following table describes the different Ethernet characteristics:

Characteristic	Description
Standard	Ethernet
Connector type	RJ45
Baud rate	Supports Ethernet "10BaseT" and "100BaseTX" with auto-negotiation
Auto-crossover	MDI / MDIX
Protocol supported	<ul style="list-style-type: none"> <li>● EcoStruxure Machine Expert Protocol</li> <li>● Modbus Client/server</li> <li>● Ethernet IP device</li> <li>● FTP server</li> <li>● HTTP server</li> <li>● SNMP</li> </ul>
IP address negotiation type supported	<ul style="list-style-type: none"> <li>● DHCP</li> <li>● BOOTP</li> <li>● Configured IP</li> </ul>
Supplied current	No

## Pin Assignment

The following illustration shows the Ethernet connector pins:

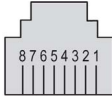

The following table describes the Ethernet connector pins:

Pin N°	Signal
1	TD+
2	TD-
3	RD+
4	-
5	-
6	RD-
7	-
8	-

For more information, please refer to Ethernet User Guide ([see page 8](#)).

**NOTE:** The controller supports the MDI/MDIX auto-crossover cable function. It is not necessary to use special Ethernet crossover cables to connect devices directly to this port (connections without an Ethernet hub or switch).

## Status LEDs

The following illustration shows the LEDs on the front panel display:

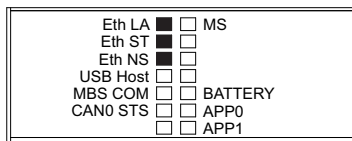

The following table describes the Ethernet status LEDs:

Marking	Description	LED	
		Color	Description
Eth LA	Ethernet Activity	Green / Yellow	See Ethernet status LED below
Eth ST	Ethernet Status	Green / Red	
Eth NS	Ethernet Network Status	Green / Red	

The following table describes the Ethernet status LED:

LED	Status	Description
Eth LA	Off	No link
	Flashing green / yellow	Power up testing. 3 flashes
	Solid green	Link at 100 Mbit/s
	Solid yellow	Link at 10 Mbit/s
	Flashing green	Activity at 100 Mbit/s
	Flashing yellow	Activity at 10 Mbit/s
Eth ST	Off	No cable connected, no IP address obtained
	Flashing green / red	Power up testing. 3 flashes
	Solid green	Port is connected and an IP address obtained
	3 flashes green	No cable connected, but the card has an IP address
	4 flashes green	Duplicated IP address detected
	5 flashes green	The card is performing a BOOTP or DHCP sequence
6 flashes green	The configured IP is invalid. The default IP is used instead.	

---

LED	Status	Description
Eth NS	Off	The device does not have an IP address or is powered off
	Flashing green / red	Power up testing. 3 flashes
	Solid green	The device has at least one established connection
	Rapid flashing green	The device has not established connections but has obtained an IP address
	Rapid flashing red	One or more of the connections in which this device is the target has timed out.
	Solid red	The device has detected that its IP address is already in use. The controller Ethernet port can not communicate using this IP address.

## CAN Port

### Overview

The following illustration shows the location of the CAN port of the controller:

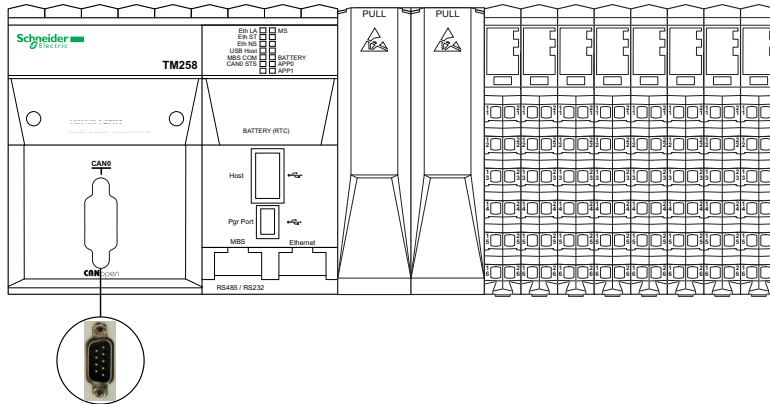

### Capabilities

The protocol and function supported by the CAN port is CANopen.



## Characteristics

The following table describes the CAN characteristics:

Characteristic	Description
Standard	CAN-CIA(ISO 11898-2:2002 Part 2) <sup>1</sup>
Connector type	Sub-D9, 9 pins male
Protocol supported	CANopen
CAN bus format	CAN2.0A
CAN power distribution	No
Maximal cable length	See Transmission Speed and Cable - CANopen Hardware Setup Manual
Isolation	See note <sup>2</sup>
Bit rate	See table below <sup>4</sup>
Line termination	No. See note <sup>3</sup>

### NOTE:

<sup>1</sup> Part 1 and Part 2 of ISO 11898:2002 are equivalent to ISO 11898:1993.

<sup>2</sup> The isolation of the electronic module is 500 Vac RMS between the electronics powered by TM5 power bus and the part powered by 24 Vdc I/O power segment connected to the module. In practice, the TM5 electronic module is installed in the bus base, and there is a bridge between TM5 power bus and 24 Vdc I/O power segment. The two power circuits reference the same functional ground (FE) through specific components designed to reduce effects of electromagnetic interference. These components are rated at 30 Vdc or 60 Vdc. This effectively reduces isolation of the entire system from the 500 Vac RMS.

<sup>3</sup> A resistor (R) is needed on each end of the CAN field bus.

<sup>4</sup> Maximum cable length is described in the following table:

Baud rate		1 Mbit/s	800 Kbit/s	500 Kbit/s	250 Kbit/s	125 Kbit/s	50 Kbit/s	20 Kbit/s	10 Kbit/s
Maximum cable length	m	4	25	100	250	500	1000	2500	5000
	ft.	13.12	82.02	328.08	820.20	1640.41	3280.83	8202.07	16404.15

## Pin Assignment

The following illustration describes the pins of the CAN port:

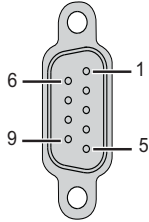

The following table describes the pins of the CAN port:

PIN N°	Signal	Description
1	N.C.	Reserved
2	CAN_L	CAN_L bus Line (Low)
3	CAN_GND	CAN 0 Vdc
4	N.C.	Reserved
5	CAN_SHLD	N.C.
6	GND	0 Vdc
7	CAN_H	CAN_H bus Line (High)
8	N.C.	Reserved
9	N.C.	Reserved

N.C.: No Connection.

The shield is connected to pin 6, the 0 Vdc pin.

**NOTE:** Pin 9 is not connected internally. The controller does not provide power on CAN\_V+.

### **⚠ WARNING**

#### **UNINTENDED EQUIPMENT OPERATION**

Do not connect wires to unused terminals and/or terminals indicated as “No Connection (N.C.)”.

**Failure to follow these instructions can result in death, serious injury, or equipment damage.**

## Status LEDs

The following illustration shows the LED on the front panel display:

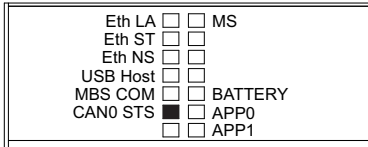

The following table describes the CAN status LED:

Marking	Description	LED	
		Color	Description
CAN0 STS	CAN 0 port status	Green / Red	See CAN0 STS status LED below

The following table describes the CAN0 STS status LED when the CAN 0 port is used as CANopen master:

CAN0 STS LED	CANopen Status	Description
OFF	No CANopen configured	CANopen is not active in the application
Single flash red / with green ON	Acceptable detected error limit threshold has been reached	The controller has detected that the maximum number of error frames has been reached or exceeded.
Double flash red / with green ON	Node Guarding or Heartbeat event	The controller has detected either a Node Guarding or Heartbeat exception for the CANopen master or slave device.
Red ON	Bus off	The CANopen bus is stopped
Green ON	The CANopen bus is operational	

For further details, please refer to the CANopen Hardware Setup Manual.

## USB Programming Port

### Overview

The following illustration shows the location of the USB mini-B programming port of the controller:

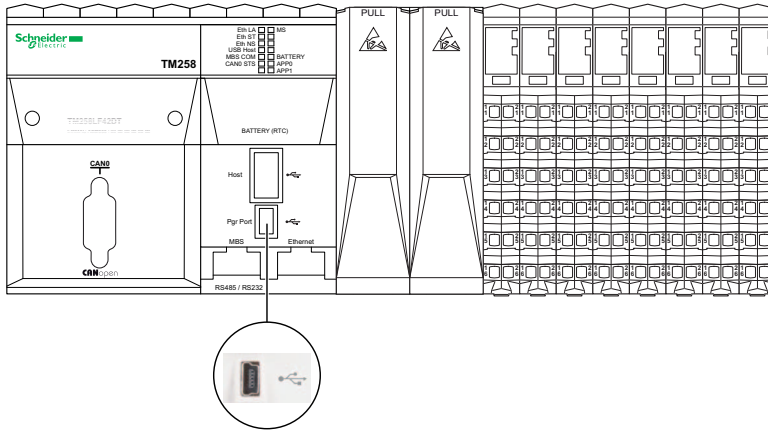

The USB Mini-B Port is the programming port you can use to connect a PC with a USB host port using EcoStruxure Machine Expert software. Using a typical USB cable, this connection is suitable for quick updates of the program or short duration connections to perform maintenance and inspect data values. It is not suitable for long-term connections such as commissioning or monitoring without the use of specially adapted cables to help minimize electromagnetic interference.

## **⚠ WARNING**

### **UNINTENDED EQUIPMENT OPERATION OR INOPERABLE EQUIPMENT**

- You must use a shielded USB cable such as a BMX XCAUSBH0\*\* secured to the functional ground (FE) of the system for any long-term connection.
- Do not connect more than one controller or bus coupler at a time using USB connections.
- Do not use the USB port(s), if so equipped, unless the location is known to be non-hazardous.

**Failure to follow these instructions can result in death, serious injury, or equipment damage.**

## Characteristics

The following table describes the characteristics for the USB Programming port:

Parameter	USB Programming Port
Standard	Hi-Speed USB 2.0 Device
Connector type	Mini-B
Maximum baud rate	480 Mbit/s
Protocol supported	<ul style="list-style-type: none"><li>● EcoStruxure Machine Expert Protocol</li><li>● FTP Server</li><li>● HTTP Server</li></ul>
Supplied current	No
Maximum cable length	3 m (9.8 ft)
Isolation	None

## USB Host Port

### Overview

The following illustration shows the location of the USB type A host port of the controller:

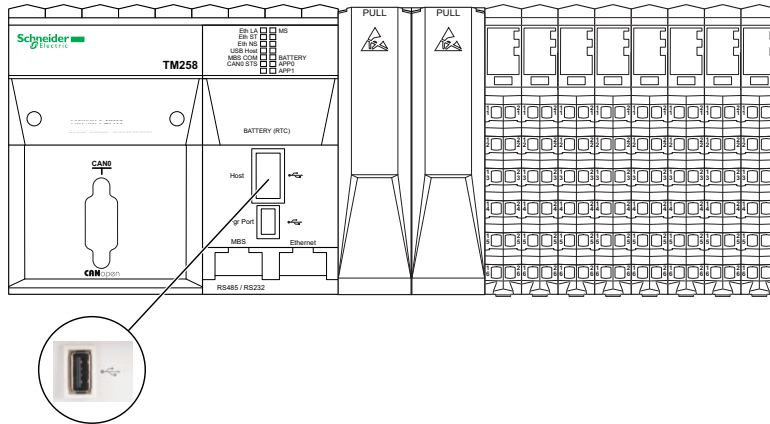

**NOTE:** The USB type A host port provides 500 mA continuous current (USB-standard) and 700 mA for short duration current spikes.

The Modicon M258 Logic Controller allows firmware updates and file transfers using a USB Memory Key. This makes it possible to perform device and data updates without the need for an EcoStruxure Machine Expert instance or the FTP Server.

The USB Host port can be used for upgrading the firmware and data files transfer with a USB Memory key.

For further details on firmware upgrades, please refer to Upgrading Controller Firmware.

For further details on data file transfers, please refer to File Transfer with USB Memory Key.

## Characteristics

The following table describes the characteristics for the USB Host port:

Characteristic	Description
Standard	Hi-speed USB 2.0 Host
Connector type	A
Maximum baud rate	480 Mbit/s
Protocol supported	Mass Storage
Supplied current	5 Vdc USB Standard
Isolation	None

The USB memory key is a standard USB memory key with the following characteristics:

- 1 GB minimum capacity
- USB 2.0 specification or less
- Formatted in FAT16 or FAT32
- A volume label must be set
- Single partition only

**NOTE:** Due to the lack of detailed specifications and the variety of typically purchased USB keys, even if a particular key appears to conform to these characteristics, it may still be unrecognized by the controller. Therefore, you should first test any given USB key to assure that it can be recognized by the controller before investing in large quantities of that key.

## Status LED

The following illustration shows the LEDs on the front panel display:

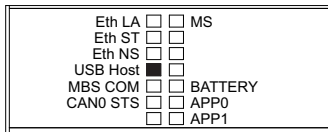

The following table describes the USB status LED:

Marking	Description	LED	
		Color	Description
USB Host	USB Host	Green / Red	<ul style="list-style-type: none"> <li>• Off when nothing is connected</li> <li>• Rapid flashing green during exchange</li> <li>• Solid green when no exchange</li> <li>• Solid red for detected script error</li> </ul>

## Serial Line Port

### Overview

The following illustration shows the location of the Serial Line port of the controller:

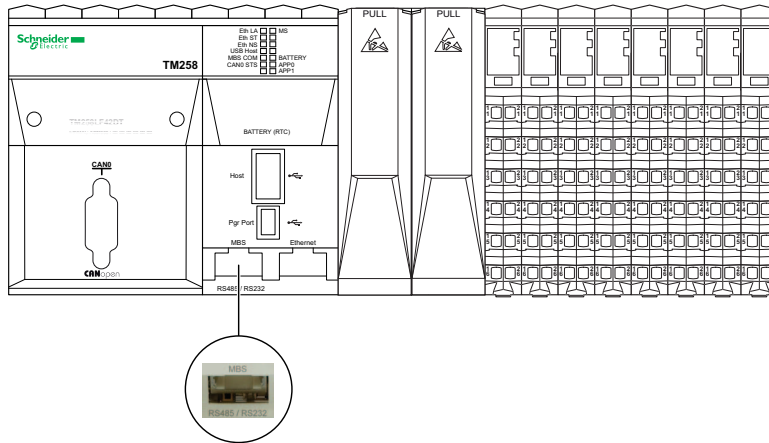

The serial line:

- is used to communicate with devices supporting the Modbus protocol as either master or slave, ASCII protocol (printer, modem...) and EcoStruxure Machine Expert Protocol (HMI,...).
- provides a 5 Vdc power distribution.

For further details, please refer to Serial Line - Planning and Installation.



## Characteristics

Characteristic	Description
Standard	RS485 <sup>1</sup> or RS232 software configured
Connector type	RJ45
Baud rate	300 up to 115200 bps <sup>2</sup>
Protocol supported	<ul style="list-style-type: none"> <li>● ASCII</li> <li>● Modbus (RTU or ASCII)</li> <li>● EcoStruxure Machine Expert</li> </ul>
Device power distribution	5 Vdc / 200 mA
5 Vdc Protection	Withstands up to 24 Vdc
Isolation	See note <sup>3</sup>
Polarization	Two 560 $\Omega$ resistors switched on or off by software configuration

### NOTE:

<sup>1</sup> To isolate the Serial Line RS485, use the TWDXCAISO T-junction box Insulation Modbus RS485.

<sup>2</sup> The maximum Baud rate for the Serial Line Port depends on the protocol used. For further information, refer to Serial Line Configuration.

<sup>3</sup> The isolation of the electronic module is 500 Vac RMS between the electronics powered by TM5 power bus and the part powered by 24 Vdc I/O power segment connected to the module. In practice, the TM5 electronic module is installed in the bus base, and there is a bridge between TM5 power bus and 24 Vdc I/O power segment. The two power circuits reference the same functional ground (FE) through specific components designed to reduce effects of electromagnetic interference. These components are rated at 30 Vdc or 60 Vdc. This effectively reduces isolation of the entire system from the 500 Vac RMS.

### Pin Assignment

The following illustration shows the pins for RS485 and RS232:

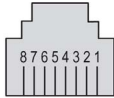

The following table describes the pins for RS485 and RS232:

Pin	RS485	RS232
1	N.C.	RxD
2	N.C.	TxD
3	N.C.	RTS
4	D1 (A+)	N.C.
5	D0 (B-)	N.C.
6	N.C.	CTS
7	5 Vdc / 200 mA	5 Vdc / 200 mA
8	0 Vdc	0 Vdc

CTS: Clear To Send

N.C.: No Connection

RTS: Ready To Send

RxD: Received Data

TxD: Transmitted Data

## ⚠ WARNING

### UNINTENDED EQUIPMENT OPERATION

Do not connect wires to unused terminals and/or terminals indicated as “No Connection (N.C.)”.

**Failure to follow these instructions can result in death, serious injury, or equipment damage.**

## Status LED

The following illustration shows the LEDs on the front panel display:

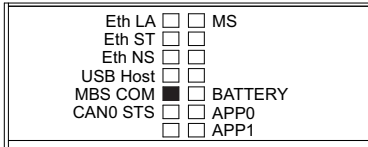

The following table describes the Serial line status LED:

Marking	Description	LED	
		Color	Description
MBS COM	Serial line port activity	Yellow	Rapid flashing when frames are received or transmitted



# Chapter 12

## PCI Slots

### PCI Slots

#### Overview

The following illustration shows the location of the controller PCI slots:

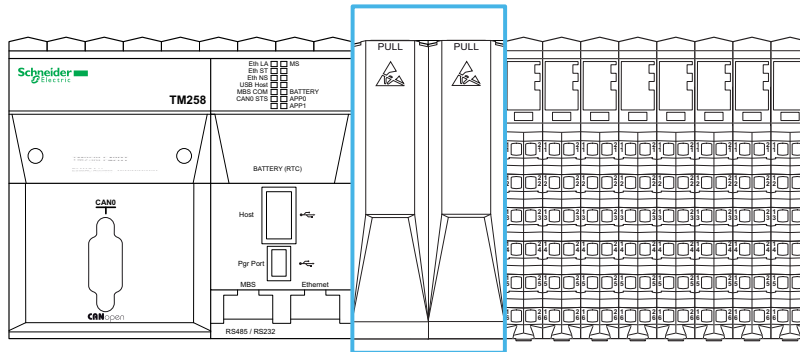

For more information, please refer to TM5 System General Rules for Implementing.

#### Description

The following illustration shows the covers of the PCI slots found on the front of the controller:

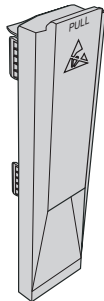

### Compatibilities

There are two PCI slots to connect up to two interface modules on the controllers (TM258LD42DT4L, TM258LF42DT4L, TM258LF66DT4L, TM258LF42DR).

The PCI modules are used for specific application expansions of the controller. They are inserted in the PCI slots of the controller:

Reference	Type	Description
TM5PCRS2	Serial line	TM5 interface electronic module, 1 RS232, electrically isolated
TM5PCRS4	Serial line	TM5 interface electronic module, 1 RS485, electrically isolated
TM5PCDPS	Profibus DP	TM5 interface electronic module, 1 RS485, electrically isolated

For further details about installing PCI modules, please refer to PCI Electronic Modules Installation

## ***NOTICE***

### **ELECTROSTATIC DISCHARGE**

- Verify that empty PCI slots have their covers in place before applying power to the controller.
- Do not touch an exposed PCI connector.

**Failure to follow these instructions can result in equipment damage.**

---

# Chapter 13

## Embedded Expert I/O

---

### Introduction

This chapter describes the embedded Expert I/O.

### What Is in This Chapter?

This chapter contains the following topics:

Topic	Page
Expert I/O	112
Fast Inputs Characteristics	117
Regular Inputs	120
Fast Outputs	122

## Expert I/O

### Overview

The following illustration shows the location of the Expert I/O of the controller:

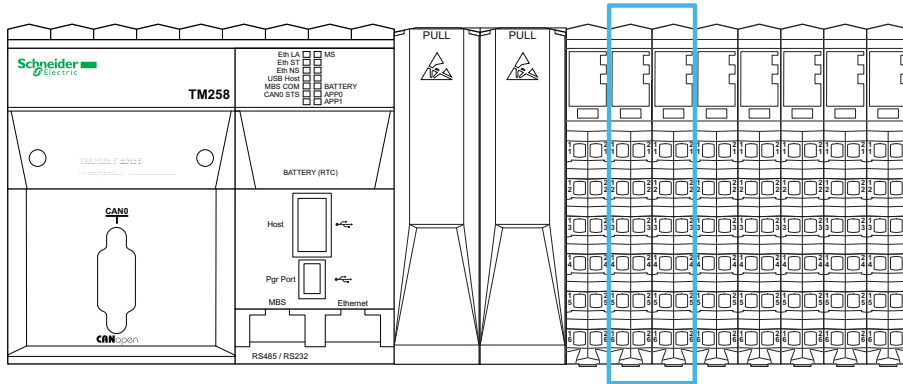

The controller has 2 modules of Embedded Expert I/O. Each module is comprised of:

- 5 fast inputs, 2 regular inputs and 2 fast outputs
- 3 commons

### Advanced Functions

Expert I/O modules support the following advanced functions:

- High speed counter (HSC)
- Event input
- Latch input
- Run/Stop input
- Pulse width modulation (PWM)
- Frequency generator
- Alarm output



## Wiring Diagram

The following illustration shows the wiring diagram of the expert I/O:

TM258LD42DT  
TM258LF42DT

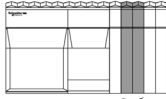

TM258LD42DT4L  
TM258LF42DT4L

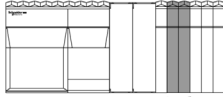

TM258LF66DT4L  
TM258LF42DR

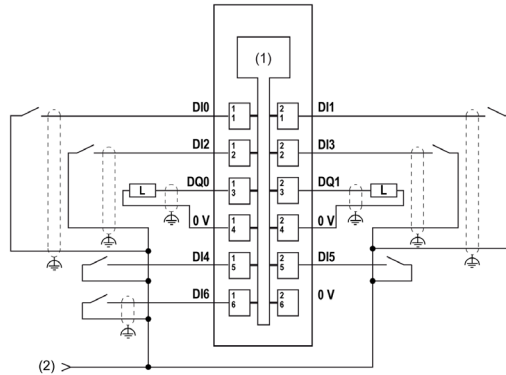
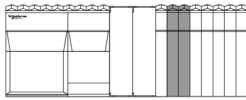

- 1 Internal electronics
- 2 24 Vdc Embedded expert modules power by external connection

The following illustration shows the wiring diagram of the expert I/O with encoder:

TM258LD42DT  
TM258LF42DT

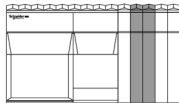

TM258LD42DT4L  
TM258LF42DT4L

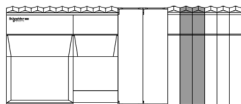

TM258LF66DT4L  
TM258LF42DR

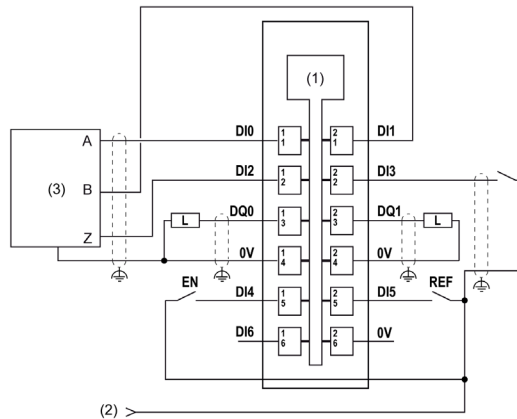
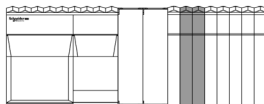

- 1 Internal electronics
- 2 24 Vdc Embedded expert modules power by external connection
- 3 Encoder

 **WARNING**

**UNINTENDED EQUIPMENT OPERATION**

- Use shielded cables for all fast I/O, analog I/O, and communication signals.
- Ground cable shields for all fast I/O, analog I/O, and communication signals at a single point<sup>1</sup>.
- Route communications and I/O cables separately from power cables.

**Failure to follow these instructions can result in death, serious injury, or equipment damage.**

<sup>1</sup>Multipoint grounding is permissible (and in some cases inevitable) if connections are made to an equipotential ground plane dimensioned to help avoid cable shield damage in the event of power system short-circuit currents.

For more information, refer to the TM5 System Wiring Rules and Recommendation.

 **WARNING**

**UNINTENDED EQUIPMENT OPERATION**

Do not connect wires to unused terminals and/or terminals indicated as “No Connection (N.C.)”.

**Failure to follow these instructions can result in death, serious injury, or equipment damage.**

### Status LEDs

The following illustration shows the LEDs for the Expert I/O:

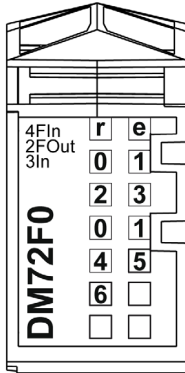

The table below describes the Expert I/O status LEDs:

LED	Color	Status	Description
r	Green	Off	No power supply
		Single Flash	Reset mode
		Flashing	Preoperational mode
		On	Normal operation
e	Red	Off	OK or no power supply
		Flashing	Indicates a current overdraw on the module.
		On	Module recovered from a power supply detected error. See configuration options in the controller programming guide.
e+r	Steady red / single green flash		Invalid firmware
0-3	Green	On	Input status of the corresponding input 0...3
0-1	Yellow	On	Output status of the corresponding output 0...1
4-6	Green	On	Input status of the corresponding input 4...6

## General Characteristics

### WARNING

#### UNINTENDED EQUIPMENT OPERATION

Do not exceed any of the rated values specified in the environmental and electrical characteristics tables.

**Failure to follow these instructions can result in death, serious injury, or equipment damage.**

The following table describes the general characteristics of the embedded Expert modules:

General characteristics		
Input voltage range		19.2...28.8 Vdc
Rated voltage		24 Vdc
Isolation	Between channels and internal bus	See note <sup>1</sup>
	Between channels	Not isolated
Number of 0 Vdc commons		3 (internally connected)
24 Vdc I/O power segment current draw		17 mA
Internal power consumption		0.4 W max.

<sup>1</sup> The isolation of the electronic module is 500 Vac RMS between the electronics powered by TM5 power bus and the part powered by 24 Vdc I/O power segment connected to the module. In practice, the TM5 electronic module is installed in the bus base, and there is a bridge between TM5 power bus and 24 Vdc I/O power segment. The two power circuits reference the same functional ground (FE) through specific components designed to reduce effects of electromagnetic interference. These components are rated at 30 Vdc or 60 Vdc. This effectively reduces isolation of the entire system from the 500 Vac RMS.

## Fast Inputs Characteristics

### Input Characteristics

#### DANGER

##### FIRE HAZARD

- Use only the correct wire sizes for the maximum current capacity of the I/O channels and power supplies.
- For relay output (2 A) wiring, use conductors of at least 0.5 mm<sup>2</sup> (AWG 20) with a temperature rating of at least 80 °C (176 °F).
- For common conductors of relay output wiring (7 A), or relay output wiring greater than 2 A, use conductors of at least 1.0 mm<sup>2</sup> (AWG 16) with a temperature rating of at least 80 °C (176 °F).

**Failure to follow these instructions will result in death or serious injury.**

#### WARNING

##### UNINTENDED EQUIPMENT OPERATION

Do not exceed any of the rated values specified in the environmental and electrical characteristics tables.

**Failure to follow these instructions can result in death, serious injury, or equipment damage.**

The following table describes the inputs characteristics of the fast inputs:

Input characteristics	
Number of fast inputs	5
Input signal type	Sink (see note <sup>2</sup> )
Rated input current	4 mA
Input impedance	6 kΩ
Input type	Type 1 (IEC 61131-2)
OFF state 0 (voltage / current)	5 Vdc max. / 1.5 mA max.
ON state 1 (voltage / current)	15 Vdc min. / 2 mA min.
Integrator filtering	0 - 1.5 - 4 or 12 ms
Anti-bounce filtering	2 μs...4 ms
Turn ON time	1 μs
Turn OFF time	1 μs

Input characteristics		
Isolation	Between channels and internal bus	See note <sup>1</sup>
	Between channels	Not isolated
Cable type	Shielded cable required	
Cable length	5 m (16.4 ft.) max.	

<sup>1</sup> The isolation of the electronic module is 500 Vac RMS between the electronics powered by TM5 power bus and the part powered by 24 Vdc I/O power segment connected to the module. In practice, the TM5 electronic module is installed in the bus base, and there is a bridge between TM5 power bus and 24 Vdc I/O power segment. The two power circuits reference the same functional ground (FE) through specific components designed to reduce effects of electromagnetic interference. These components are rated at 30 Vdc or 60 Vdc. This effectively reduces isolation of the entire system from the 500 Vac RMS.

<sup>2</sup> Connected to the 24 Vdc embedded Expert modules

### Integrator Filter Principle

The integrator filter is designed to reduce the effect of noise. Setting a filter value allows the controller to ignore some sudden changes of input levels caused by noise.

The following timing diagram illustrates the integrator filter effects for a value of 4 ms:

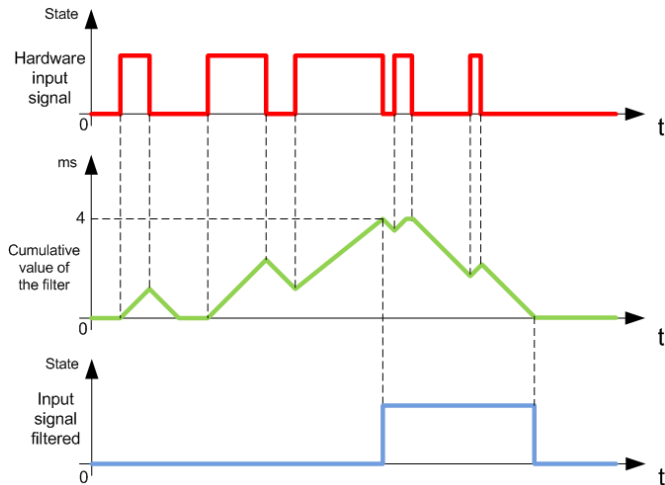

**NOTE:** The value selected for the filter's time parameter specifies the cumulative time in ms that must elapse before the input is recognized as logical 1, as well as specifying how long the filtered input signal remains at logical 1.

## Bounce Filter Principle

The bounce filter is designed to reduce the bounce effect at the inputs. Setting a bounce filter value allows the controller to ignore some sudden changes of input levels caused by contact bounce. The bounce filter is only available on the fast inputs.

The following timing diagram illustrates the anti-bounce filter effects:

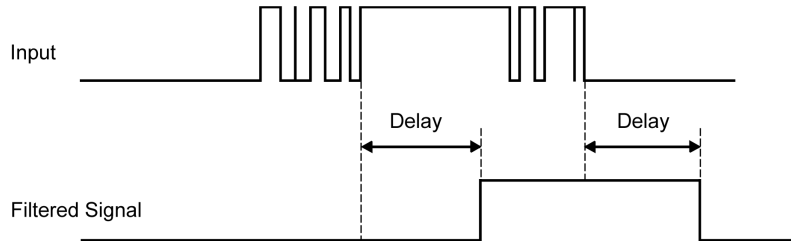

## Regular Inputs

### Input Characteristics

#### DANGER

##### FIRE HAZARD

- Use only the correct wire sizes for the maximum current capacity of the I/O channels and power supplies.
- For relay output (2 A) wiring, use conductors of at least 0.5 mm<sup>2</sup> (AWG 20) with a temperature rating of at least 80 °C (176 °F).
- For common conductors of relay output wiring (7 A), or relay output wiring greater than 2 A, use conductors of at least 1.0 mm<sup>2</sup> (AWG 16) with a temperature rating of at least 80 °C (176 °F).

**Failure to follow these instructions will result in death or serious injury.**

#### WARNING

##### UNINTENDED EQUIPMENT OPERATION

Do not exceed any of the rated values specified in the environmental and electrical characteristics tables.

**Failure to follow these instructions can result in death, serious injury, or equipment damage.**

The following table describes the characteristics of the regular inputs:

Input characteristics	
Number of input channels	2
Input signal type	Sink (see note <sup>2</sup> )
Rated input current	4 mA
Input impedance	6 kΩ
Input type	Type 1 (IEC 61131-2)
OFF state 0 (voltage / current)	5 Vdc max. / 1.5 mA max.
ON state 1 (voltage / current)	15 Vdc min. / 2 mA min.
Integrator filtering	0 - 1.5 - 4 or 12 ms



Input characteristics		
Isolation	Between channels and internal bus	See note <sup>1</sup>
	Between channels	Not isolated
Cable length		30 m (98.4 ft.) max.

<sup>1</sup> The isolation of the electronic module is 500 Vac RMS between the electronics powered by TM5 power bus and the part powered by 24 Vdc I/O power segment connected to the module. In practice, the TM5 electronic module is installed in the bus base, and there is a bridge between TM5 power bus and 24 Vdc I/O power segment. The two power circuits reference the same functional ground (FE) through specific components designed to reduce effects of electromagnetic interference. These components are rated at 30 Vdc or 60 Vdc. This effectively reduces isolation of the entire system from the 500 Vac RMS.

<sup>2</sup> Connected to the 24 Vdc embedded Expert modules

For further details on integrator filtering, please refer to Integrator Filter Principle ([see page 118](#)).

For further details on anti-bounce filtering, please refer to Bounce Filter Principle ([see page 119](#)).

## Fast Outputs

### Output Characteristics

**⚠ DANGER**

**FIRE HAZARD**

- Use only the correct wire sizes for the maximum current capacity of the I/O channels and power supplies.
- For relay output (2 A) wiring, use conductors of at least 0.5 mm<sup>2</sup> (AWG 20) with a temperature rating of at least 80 °C (176 °F).
- For common conductors of relay output wiring (7 A), or relay output wiring greater than 2 A, use conductors of at least 1.0 mm<sup>2</sup> (AWG 16) with a temperature rating of at least 80 °C (176 °F).

**Failure to follow these instructions will result in death or serious injury.**

**⚠ WARNING**

**UNINTENDED EQUIPMENT OPERATION**

Do not exceed any of the rated values specified in the environmental and electrical characteristics tables.

**Failure to follow these instructions can result in death, serious injury, or equipment damage.**

For additional important information about fast output protection, refer to Protecting Outputs from Inductive Load Damage.

The following table describes the characteristics of the fast outputs:

Output characteristics		
Number of fast outputs	2	
Output signal type	Sink / Source	
Output type	Push / pull	
Rated Output current at 24 Vdc	0.5 A max.	
Maximum switching frequency	0.2 A up to 25 KHz	
	0.05 A up to 100 KHz	
Protection against overload / short-circuit	Yes (device becomes inoperable if current exceeds 0.625 A)	
Delay time	From 0 to 1	2 μs
	From 1 to 0	4 μs

Output characteristics		
Isolation	Between channels	None (referenced to 0 Vdc of the 24 Vdc embedded expert modules power)
	Between output and internal bus	See note <sup>1</sup>
Cable type		Shielded cable required
Cable length		5 m (16.4 ft.) max.

<sup>1</sup> The isolation of the electronic module is 500 Vac RMS between the electronics powered by TM5 power bus and the part powered by 24 Vdc I/O power segment connected to the module. In practice, the TM5 electronic module is installed in the bus base, and there is a bridge between TM5 power bus and 24 Vdc I/O power segment. The two power circuits reference the same functional ground (FE) through specific components designed to reduce effects of electromagnetic interference. These components are rated at 30 Vdc or 60 Vdc. This effectively reduces isolation of the entire system from the 500 Vac RMS.

For further details on integrator filtering, please refer to Integrator Filter Principle ([see page 118](#)).

For further details on anti-bounce filtering, please refer to Bounce Filter Principle ([see page 119](#)).



---

# Chapter 14

## Embedded Regular I/O

---

### Introduction

This chapter describes the embedded regular I/O.

### What Is in This Chapter?

This chapter contains the following topics:

Topic	Page
Digital DI6DE	126
Digital DI12DE	130
Digital DO12TE	134
Analog AI4LE	139
Relay DO6RE	143

## Digital DI6DE

### Overview

The digital DI6DE electronic module is equipped with 6 sink inputs.

### DANGER

#### FIRE HAZARD

- Use only the correct wire sizes for the maximum current capacity of the I/O channels and power supplies.
- For relay output (2 A) wiring, use conductors of at least 0.5 mm<sup>2</sup> (AWG 20) with a temperature rating of at least 80 °C (176 °F).
- For common conductors of relay output wiring (7 A), or relay output wiring greater than 2 A, use conductors of at least 1.0 mm<sup>2</sup> (AWG 16) with a temperature rating of at least 80 °C (176 °F).

**Failure to follow these instructions will result in death or serious injury.**

### WARNING

#### UNINTENDED EQUIPMENT OPERATION

Do not exceed any of the rated values specified in the environmental and electrical characteristics tables.

**Failure to follow these instructions can result in death, serious injury, or equipment damage.**

## Input Characteristics

The table describes the input characteristics of the DI6DE electronic module:

Input Characteristics		
Number of input channels		6
Wiring type		1 or 2 wires
Input type		Type 1
Signal type		Sink
Rated input voltage		24 Vdc
Input voltage range		20.4...28.8 Vdc
Rated input current at 24 Vdc		3.75 mA
Input impedance		6.4 k $\Omega$
OFF state		5 Vdc max.
ON state		15 Vdc min.
Input filter	Hardware	$\leq 100 \mu\text{s}$
	Software	Default 1 ms, can be configured between 0 and 25 ms in 0.2 ms intervals.
Isolation	Between input and internal bus	See note <sup>1</sup>
	Between channels	Not isolated
24 Vdc I/O segment current draw		37 mA (all inputs On)

<sup>1</sup> The isolation of the electronic module is 500 Vac RMS between the electronics powered by TM5 power bus and the part powered by 24 Vdc I/O power segment connected to the module. In practice, the TM5 electronic module is installed in the bus base, and there is a bridge between TM5 power bus and 24 Vdc I/O power segment. The two power circuits reference the same functional ground (FE) through specific components designed to reduce effects of electromagnetic interference. These components are rated at 30 Vdc or 60 Vdc. This effectively reduces isolation of the entire system from the 500 Vac RMS.

### Wiring Diagram

The following illustration describes the wiring diagram of the DI6DE:  
**TM258LF42DR**

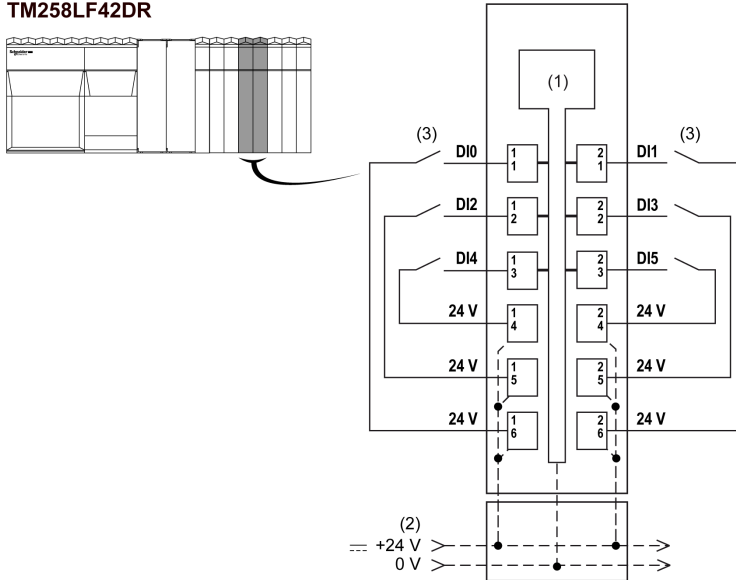

- 1 Internal electronics
- 2 24 Vdc I/O power segment integrated into the bus bases
- 3 2-wire sensor

## ⚠ WARNING

### UNINTENDED EQUIPMENT OPERATION

Do not connect wires to unused terminals and/or terminals indicated as “No Connection (N.C.)”.  
**Failure to follow these instructions can result in death, serious injury, or equipment damage.**



## Status LEDs

The following illustration shows the LEDs for DI6DE:

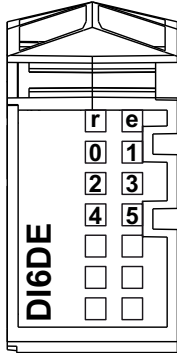

The table below shows the DI6DE status LEDs:

LEDs	Color	Status	Description
r	Green	Off	No power supply
		Single Flash	Reset mode
		Flashing	Preoperational mode
		On	Normal operation
e	Red	Off	OK or no power supply
e+r	Steady red / single green flash		Invalid firmware
0-5	Green	Off	Corresponding input deactivated
		On	Corresponding input activated

## Digital DI12DE

### Overview

The digital DI12DE module is equipped with 12 sink inputs.

### DANGER

#### FIRE HAZARD

- Use only the correct wire sizes for the maximum current capacity of the I/O channels and power supplies.
- For relay output (2 A) wiring, use conductors of at least 0.5 mm<sup>2</sup> (AWG 20) with a temperature rating of at least 80 °C (176 °F).
- For common conductors of relay output wiring (7 A), or relay output wiring greater than 2 A, use conductors of at least 1.0 mm<sup>2</sup> (AWG 16) with a temperature rating of at least 80 °C (176 °F).

**Failure to follow these instructions will result in death or serious injury.**

### WARNING

#### UNINTENDED EQUIPMENT OPERATION

Do not exceed any of the rated values specified in the environmental and electrical characteristics tables.

**Failure to follow these instructions can result in death, serious injury, or equipment damage.**

## Input Characteristics

The table below shows the characteristics of the DI12DE electronic module:

Characteristic		Value
Number of input channels		12
Wiring type		1 wire
Input type		Type 1
Signal type		Sink
Rated input voltage		24 Vdc
Input voltage range		20.4...28.8 Vdc
De-rating	55...60 °C (131...140 °F)	11 channels
Rated input current at 24 Vdc		3.75 mA
Input impedance		6.4 kΩ
OFF state		5 Vdc max.
ON state		15 Vdc min.
Input filter	Hardware	≤100 μs
	Software	Default 1 ms, can be configured between 0 and 25 ms in 0.2 ms intervals.
Isolation	Between input and internal bus	See note <sup>1</sup>
	Between channels	Not isolated
24 Vdc I/O segment current draw		73 mA (all inputs On)

<sup>1</sup> The isolation of the electronic module is 500 Vac RMS between the electronics powered by TM5 power bus and the part powered by 24 Vdc I/O power segment connected to the module. In practice, the TM5 electronic module is installed in the bus base, and there is a bridge between TM5 power bus and 24 Vdc I/O power segment. The two power circuits reference the same functional ground (FE) through specific components designed to reduce effects of electromagnetic interference. These components are rated at 30 Vdc or 60 Vdc. This effectively reduces isolation of the entire system from the 500 Vac RMS.

## Wiring Diagram

The following illustration describes the wiring diagram of the DI12DE:

**TM258LD42DT**

**TM258LF42DT**

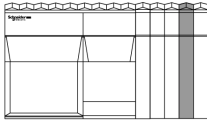

**TM258LD42DT4L**

**TM258LF42DT4L**

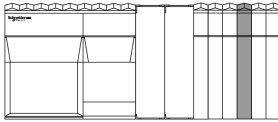

**TM258LF66DT4L**

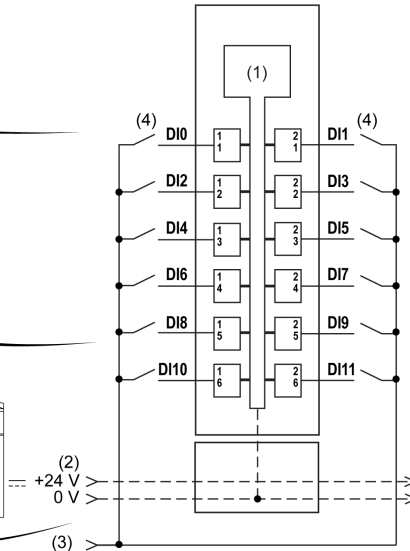
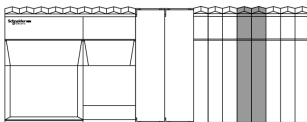

- 1 Internal electronics
- 2 24 Vdc I/O power segment integrated into the bus bases
- 3 24 Vdc I/O power segment by external connection
- 4 2-wire sensor

### **⚠ WARNING**

#### **POTENTIAL EXPLOSION OR FIRE**

Connect the returns from the devices to the same power source as the 24 Vdc I/O power segment serving the module.

**Failure to follow these instructions can result in death, serious injury, or equipment damage.**

### **⚠ WARNING**

#### **UNINTENDED EQUIPMENT OPERATION**

Do not connect wires to unused terminals and/or terminals indicated as “No Connection (N.C.)”.

**Failure to follow these instructions can result in death, serious injury, or equipment damage.**

## Status LEDs

The following illustration shows the LEDs for DI12DE:

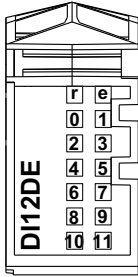

The table below shows the DI12DE status LEDs:

LEDs	Color	Status	Description
r	Green	Off	No power supply
		Single Flash	Reset mode
		Flashing	Preoperational mode
		On	Normal operation
e	Red	Off	OK or no power supply
e+r	Steady red / single green flash		Invalid firmware
0-11	Green	Off	Corresponding input deactivated
		On	Corresponding input activated

## Digital DO12TE

### Overview

The digital DO12TE electronic module is equipped with 12 source outputs.

### DANGER

#### FIRE HAZARD

- Use only the correct wire sizes for the maximum current capacity of the I/O channels and power supplies.
- For relay output (2 A) wiring, use conductors of at least 0.5 mm<sup>2</sup> (AWG 20) with a temperature rating of at least 80 °C (176 °F).
- For common conductors of relay output wiring (7 A), or relay output wiring greater than 2 A, use conductors of at least 1.0 mm<sup>2</sup> (AWG 16) with a temperature rating of at least 80 °C (176 °F).

**Failure to follow these instructions will result in death or serious injury.**

### WARNING

#### UNINTENDED EQUIPMENT OPERATION

Do not exceed any of the rated values specified in the environmental and electrical characteristics tables.

**Failure to follow these instructions can result in death, serious injury, or equipment damage.**

## Output Characteristics

For additional important information about fast output protection, refer to Protecting Outputs from Inductive Load Damage.

The following table describes the characteristics of the DO12TE electronic module:

Characteristic		Value
Output channels		12
Wiring type		1 wire
Output type		Transistor
Signal type		Source
Output current		0.5 A max. per output
Total output current		6 A max.
Rated output voltage		24 Vdc
Output voltage range		20.4 ... 28.8 Vdc
De-rating at 60°C (140°F)		I=0.4 A max. by channel
Voltage drop		0.3 Vdc max. at 0.5 A rated current
Diagnostic status		Output monitoring with 10 ms delay
Leakage current when switched off		5 µA
Turn on time		300 µs max.
Turn off time		300 µs max.
Output protection		Against short-circuit and overload, thermal protection
Short-circuit output peak current		12 A max.
Automatic rearming after short-circuit or overload		Yes, 10 ms min. depending on internal temperature
Protection against reverse polarity		Yes
Clamping voltage		Typ. 50 Vdc
Switching frequency	Resistive load	500 Hz Max.
	Inductive load	See the switching inductive load characteristics ( <i>see page 136</i> )

Characteristic		Value
Isolation	Between input and internal bus	See note <sup>1</sup>
	Between channels	Not isolated
24 Vdc I/O segment current draw		48 mA

<sup>1</sup> The isolation of the electronic module is 500 Vac RMS between the electronics powered by TM5 power bus and the part powered by 24 Vdc I/O power segment connected to the module. In practice, the TM5 electronic module is installed in the bus base, and there is a bridge between TM5 power bus and 24 Vdc I/O power segment. The two power circuits reference the same functional ground (FE) through specific components designed to reduce effects of electromagnetic interference. These components are rated at 30 Vdc or 60 Vdc. This effectively reduces isolation of the entire system from the 500 Vac RMS.

### Switching Inductive Load

The following curves provide the switching inductive load characteristics for the DO12TE electronic module.

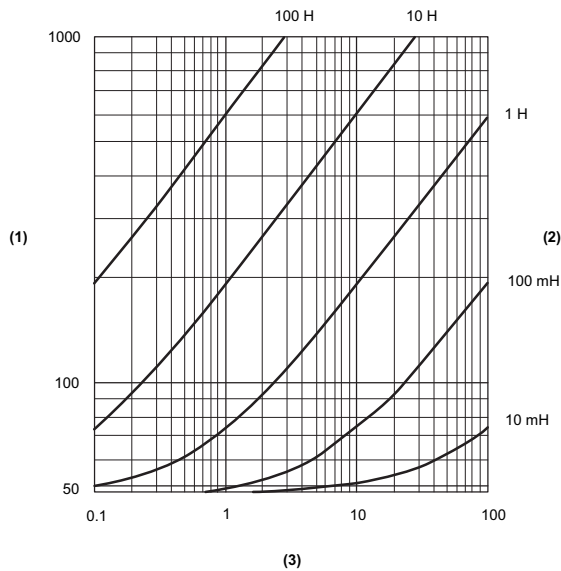

- 1 Coil resistance in  $\Omega$
- 2 Coil inductance
- 3 Max. operating cycles / second



## Wiring Diagram

The following illustration shows the wiring diagram of the DO12TE:

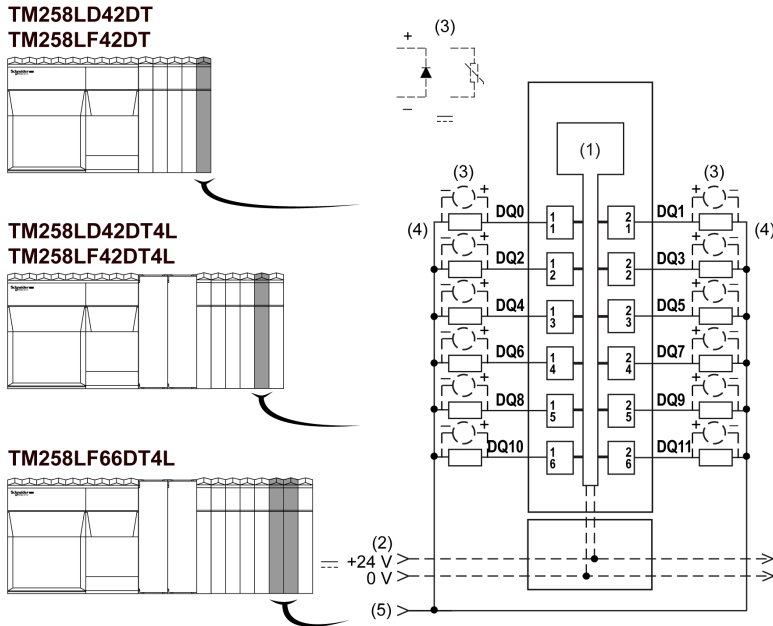

- 1 Internal electronics
- 2 24 Vdc I/O power segment integrated into the bus bases
- 3 Inductive load protection
- 4 2-wire load
- 5 0 Vdc I/O power segment by external connection

**NOTE:** The assigned fuse values have been specified for the maximum current characteristics of the controller or expansion I/O and associated commons. You may have other considerations that are applicable based on the unique types of input and output devices you connect, or conformance to local, national or applicable certification regulations and standards, and you should size your fuses accordingly.

## **⚠ WARNING**

### **POTENTIAL EXPLOSION OR FIRE**

Connect the returns from the devices to the same power source as the 24 Vdc I/O power segment serving the module.

**Failure to follow these instructions can result in death, serious injury, or equipment damage.**

## ⚠ WARNING

### UNINTENDED EQUIPMENT OPERATION

Do not connect wires to unused terminals and/or terminals indicated as “No Connection (N.C.)”.

**Failure to follow these instructions can result in death, serious injury, or equipment damage.**

### Status LEDs

The following illustration shows the LEDs for DO12TE:

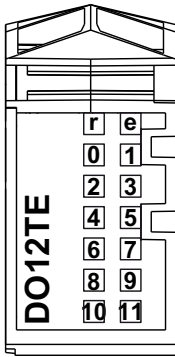

The following table describes the DO12TE status LEDs:

LEDs	Color	Status	Description
r	Green	Off	No power supply
		Single Flash	Reset mode
		Flashing	Preoperational mode
		On	Normal operation
e	Red	Off	OK or no power supply
		Single flash	Detected error for an output channel
e+r	Steady Red / Single Green flash		Invalid firmware
0- 11	Yellow	Off	Corresponding output deactivated
		On	Corresponding output activated

## Analog AI4LE

### Overview

The analog AI4LE electronic module is equipped with 4 12-bit inputs.

### DANGER

#### FIRE HAZARD

- Use only the correct wire sizes for the maximum current capacity of the I/O channels and power supplies.
- For relay output (2 A) wiring, use conductors of at least 0.5 mm<sup>2</sup> (AWG 20) with a temperature rating of at least 80 °C (176 °F).
- For common conductors of relay output wiring (7 A), or relay output wiring greater than 2 A, use conductors of at least 1.0 mm<sup>2</sup> (AWG 16) with a temperature rating of at least 80 °C (176 °F).

**Failure to follow these instructions will result in death or serious injury.**

### WARNING

#### UNINTENDED EQUIPMENT OPERATION

Do not exceed any of the rated values specified in the environmental and electrical characteristics tables.

**Failure to follow these instructions can result in death, serious injury, or equipment damage.**

## Input Characteristics

The following table describes the characteristics of the AI4LE electronic module:

Characteristic	Voltage input	Current input
Number of input channels	4	
Input range	-10... +10 Vdc	0...20 mA / 4...20 mA
Input impedance	20 MΩ min.	-
Load impedance	-	400 Ω max.
Sample duration time	400 μs for all inputs without filtering 1 ms for all inputs with filtering	
Input type	Differential	
Conversion mode	Successive Approximative Register	
Input filter	Low pass 3rd order / cut-off frequency 1 kHz	
Input tolerance - maximum deviation at ambient 25° C (77°F)	< 0.08% of the measurement	< 0.08% of the measurement
Input tolerance - temperature drift	0.006% / °C of the measurement	0.009% / °C of the measurement
Input tolerance - non linearity	< 0.025% of the full scale (20 V)	< 0.05% of the full scale (20 mA)
Digital resolution	12 bit + sign	12 bit
Resolution value	2.441 mV	4.883 μA
Common mode rejection	DC	70 dB min.
	50 Hz	70 dB min.
Cable type	Shielded cable required	
Crosstalk rejection between channels	70 dB min.	
Isolation between channels	Not isolated	
Isolation between channels and bus	See note <sup>1</sup> .	
Permitted input signal	±30 Vdc max.	±50 mA max.
Input protection	Protection against wiring with 24 Vdc supply voltage	
Common mode voltage allowable between channels	±12 Vdc max.	
24 Vdc I/O power segment current draw	48 mA	

<sup>1</sup> The isolation of the electronic module is 500 Vac RMS between the electronics powered by TM5 power bus and the part powered by 24 Vdc I/O power segment connected to the module. In practice, the TM5 electronic module is installed in the bus base, and there is a bridge between TM5 power bus and 24 Vdc I/O power segment. The two power circuits reference the same functional ground (FE) through specific components designed to reduce effects of electromagnetic interference. These components are rated at 30 Vdc or 60 Vdc. This effectively reduces isolation of the entire system from the 500 Vac RMS.

## Wiring Diagram

The following illustration shows the wiring diagram of the AI4LE:

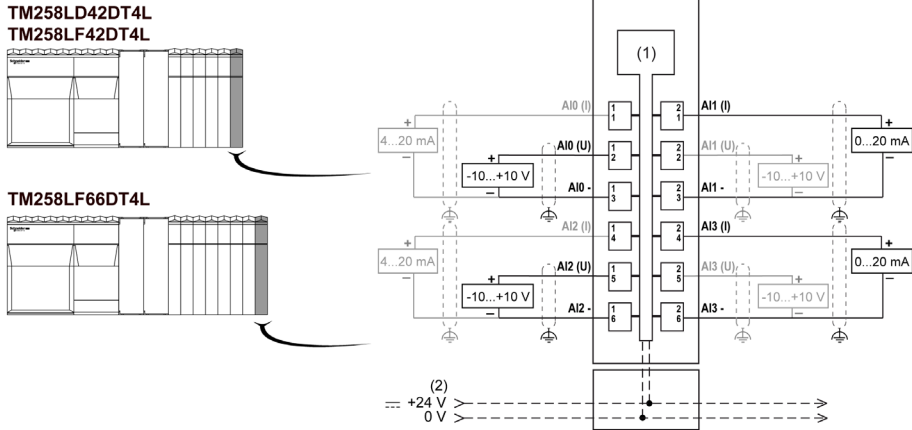

- 1 Internal electronics
- 2 24 Vdc I/O power segment integrated into the bus bases
- I Current
- U Voltage

## ⚠ WARNING

### UNINTENDED EQUIPMENT OPERATION

- Use shielded cables for all fast I/O, analog I/O, and communication signals.
- Ground cable shields for all fast I/O, analog I/O, and communication signals at a single point<sup>1</sup>.
- Route communications and I/O cables separately from power cables.

**Failure to follow these instructions can result in death, serious injury, or equipment damage.**

<sup>1</sup>Multipoint grounding is permissible (and in some cases inevitable) if connections are made to an equipotential ground plane dimensioned to help avoid cable shield damage in the event of power system short-circuit currents.

For more information, refer to the TM5 System Wiring Rules and Recommendation.

 **WARNING**

**UNINTENDED EQUIPMENT OPERATION**

Do not connect wires to unused terminals and/or terminals indicated as “No Connection (N.C.)”.

**Failure to follow these instructions can result in death, serious injury, or equipment damage.**

If you have physically wired the analog channel for a voltage signal and you configure the channel for a current signal in EcoStruxure Machine Expert, you may damage the analog circuit.

### Status LEDs

The following illustration shows LEDs for AI4LE:

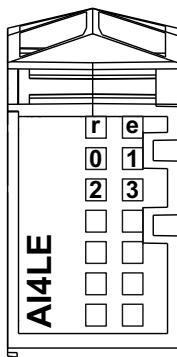

The following table describes the AI4LE status LEDs:

LEDs	Color	Status	Description
r	Green	Off	No power supply
		Single Flash	Reset mode
		Flashing	Preoperational mode
		On	Normal operation
e	Red	Off	OK or no power supply
		On	Detected error or reset state
		Double Flash	System detected error: <ul style="list-style-type: none"> <li>● Scan time overrun</li> <li>● Synchronization detected error</li> </ul>
0-3	Green	Off	Open connection or sensor is disconnected
		On	The analog/digital converter is running, value is available

## Relay DO6RE

### Overview

The relay DO6RE electronic module is equipped with 6 relay outputs.

### DANGER

#### FIRE HAZARD

- Use only the correct wire sizes for the maximum current capacity of the I/O channels and power supplies.
- For relay output (2 A) wiring, use conductors of at least 0.5 mm<sup>2</sup> (AWG 20) with a temperature rating of at least 80 °C (176 °F).
- For common conductors of relay output wiring (7 A), or relay output wiring greater than 2 A, use conductors of at least 1.0 mm<sup>2</sup> (AWG 16) with a temperature rating of at least 80 °C (176 °F).

**Failure to follow these instructions will result in death or serious injury.**

### WARNING

#### UNINTENDED EQUIPMENT OPERATION

Do not exceed any of the rated values specified in the environmental and electrical characteristics tables.

**Failure to follow these instructions can result in death, serious injury, or equipment damage.**

**Durability Electric**

The curves below provide the expected life of the relay contacts for the DO6RE electronic module.

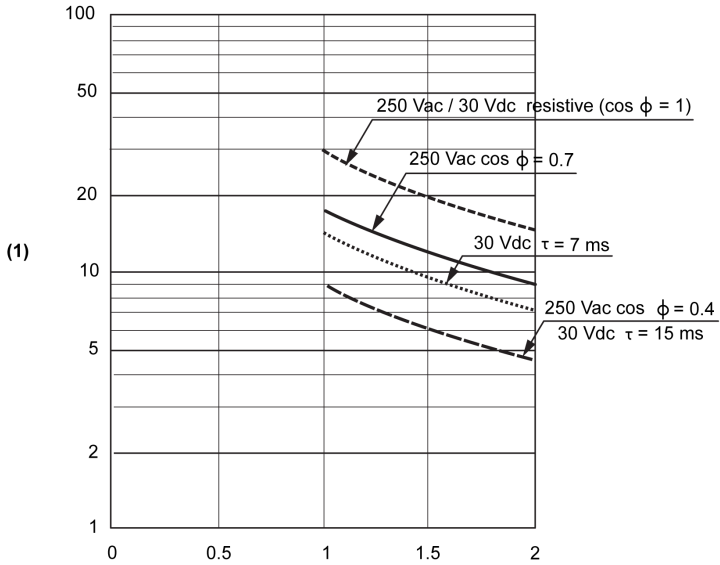

(2)

- 1 Switching procedures ( $\times 10^4$ )
- 2 Switching current in A



## Output Characteristics

The table below describes the characteristics of DO6RE electronic module:

Characteristic		Value
Output channels		6
Wiring type		6 contacts
Contact type		NO (Normally Open)
Output current		24 Vdc / 2 A (Resistive load) 240 Vac / 2 A (cos $\Phi$ = 1)
Switching frequency		3600 cycles by hour max.
Relay dielectric maximum voltage		2000 V rms, 50/60 Hz for 1 mn
Maximum switching load		264 Vac / 125 Vdc
Minimum switching load		5 Vdc at 1 mA
Maximum power of filament lamp		1.2 W
Turn on time		12 ms max.
Turn off time		10 ms max.
Protective circuit <sup>2</sup>	Internal	None
	External DC AC	Flyback diode, RC combination or Varistor RC combination or Varistor
Automatic rearming after short-circuit or overload		Yes, 10 ms min. depending on internal temperature
Switching capacity	Minimum	10 mA at 5 Vdc
	Maximum	150 W / 1250 VA
Protection against reverse polarity		Yes
Isolation	Between channels and bus	See note <sup>1</sup>
	Between outputs	Not isolated
Mechanical durability		Typically $2 \times 10^7$ cycles or more
24 Vdc I/O segment current draw		0 mA

<sup>1</sup> Refer to Protecting Outputs from Inductive Load Damage for additional important information on this topic.

<sup>2</sup> The isolation of the electronic module is 500 Vac RMS between the electronics powered by TM5 power bus and the part powered by 24 Vdc I/O power segment connected to the module. In practice, the TM5 electronic module is installed in the bus base, and there is a bridge between TM5 power bus and 24 Vdc I/O power segment. The two power circuits reference the same functional ground (FE) through specific components designed to reduce effects of electromagnetic interference. These components are rated at 30 Vdc or 60 Vdc. This effectively reduces isolation of the entire system from the 500 Vac RMS.

## Wiring Diagram

The following illustration describes the wiring diagram of the DO6RE:

### TM258LF42DR

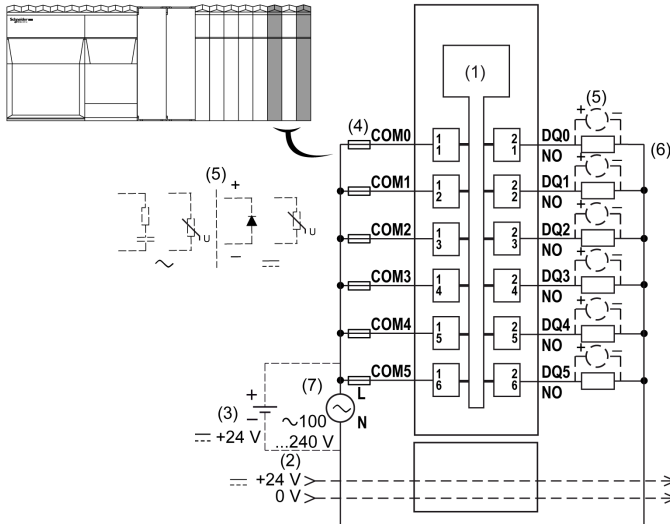

- 1 Internal electronics
- 2 24 Vdc I/O power segment integrated into the bus bases
- 3 External isolated power supply 24 Vdc
- 4 External fuse type T slow-blow 2 A 250 Vac
- 5 Inductive load protection
- 6 2-wire load
- 7 External power supply 100...240 Vac

**NOTE:** The assigned fuse values have been specified for the maximum current characteristics of the controller or expansion I/O and associated commons. You may have other considerations that are applicable based on the unique types of input and output devices you connect, or conformance to local, national or applicable certification regulations and standards, and you should size your fuses accordingly.

**NOTE:** Connect the 0 Vdc power circuits together and to the functional ground (FE) of your system to meet the EMC requirements.

## DANGER

### HAZARD OF ELECTRIC SHOCK, EXPLOSION, OVERHEATING AND FIRE

- Do not connect the modules directly to line voltage.
- Use only isolating PELV systems according to IEC 61140 to supply power to the modules.
- Connect the 0 Vdc of the external power supplies to FE (Functional Earth/ground).

**Failure to follow these instructions will result in death or serious injury.**

## WARNING

### UNINTENDED EQUIPMENT OPERATION

Do not connect wires to unused terminals and/or terminals indicated as “No Connection (N.C.)”.

**Failure to follow these instructions can result in death, serious injury, or equipment damage.**

**NOTE:** Refer to Protecting Outputs from Inductive Load Damage for additional important information on this topic.

## Status LEDs

The following illustration shows the LEDs for DO6RE:

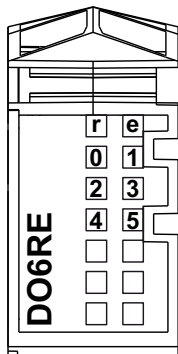

The table below shows the DO6RE status LEDs:

LEDs	Color	Status	Description
r	Green	Off	No power supply
		Single Flash	Reset mode
		Flashing	Preoperational mode
		On	Normal operation
e	Red	Off	OK or no power supply
		On	Detected error or reset state
e+r	Steady red / single green flash		Invalid firmware
0-5	Green	Off	Corresponding output deactivated
		On	Corresponding output activated

---

# Chapter 15

## Connecting the Modicon M258 Logic Controller to a PC

---

### Connecting the Controller to a PC

#### Overview

To transfer, run, and monitor the applications, connect the controller to a computer, that has EcoStruxure Machine Expert installed, using either a USB cable or an Ethernet connection (for those references that support an Ethernet port).

### ***NOTICE***

#### **INOPERABLE EQUIPMENT**

Always connect the communication cable to the PC before connecting it to the controller.

**Failure to follow these instructions can result in equipment damage.**

#### USB Mini-B Port Connection

**TCSXCNAMUM3P:** This USB cable is suitable for short duration connections such as quick updates or retrieving data values.

**BMXXCAUSBH045:** Grounded and shielded, this USB cable is suitable for long duration connections.

**NOTE:** You can only connect 1 controller or any other device associated with EcoStruxure Machine Expert and its component to the PC at any one time.

The USB Mini-B Port is the programming port you can use to connect a PC with a USB host port using EcoStruxure Machine Expert software. Using a typical USB cable, this connection is suitable for quick updates of the program or short duration connections to perform maintenance and inspect data values. It is not suitable for long-term connections such as commissioning or monitoring without the use of specially adapted cables to help minimize electromagnetic interference.

### **WARNING**

#### **UNINTENDED EQUIPMENT OPERATION OR INOPERABLE EQUIPMENT**

- You must use a shielded USB cable such as a BMX XCAUSBH0\*\* secured to the functional ground (FE) of the system for any long-term connection.
- Do not connect more than one controller or bus coupler at a time using USB connections.
- Do not use the USB port(s), if so equipped, unless the location is known to be non-hazardous.

**Failure to follow these instructions can result in death, serious injury, or equipment damage.**

The communication cable should be connected to the PC first to minimize the possibility of electrostatic discharge affecting the controller.

The following illustration shows the USB connection to a PC:

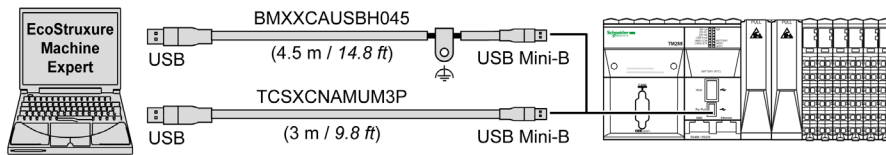

To connect the USB cable to your controller, follow the steps below:

Step	Action
1	<p><b>1a</b> If making a long-term connection using the cable BMXXCAUSBH045, or other cable with a ground shield connection, securely connect the shield connector to the functional ground (FE) or protective ground (PE) of your system before connecting the cable to your controller and your PC.</p> <p><b>1b</b> If making a short-term connection using the cable TCSXCNAMUM3P or other non-grounded USB cable, proceed to step 2.</p>
2	Connect the USB cable connector to the PC.
3	Connect the Mini connector of your USB cable to the controller USB connector.

### Ethernet Port Connection

You can also connect the controller to a PC using an Ethernet cable.

The following illustration shows the Ethernet connection to a PC:

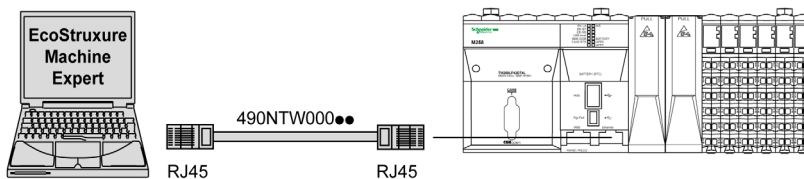

To connect the controller to the PC, do the following:

Step	Action
1	Connect the Ethernet cable to the PC.
2	Connect the Ethernet cable to the Ethernet port on the controller.



## A

### **analog input**

Converts received voltage or current levels into numerical values. You can store and process these values within the logic controller.

### **application**

A program including configuration data, symbols, and documentation.

### **ASCII**

*(American standard code for Information Interchange)* A protocol for representing alphanumeric characters (letters, numbers, certain graphics, and control characters).

## B

### **Boot application**

*(boot application)* The binary file that contains the application. Usually, it is stored in the controller and allows the controller to boot on the application that the user has generated.

### **BOOTP**

*(bootstrap protocol)* A UDP network protocol that can be used by a network client to automatically obtain an IP address (and possibly other data) from a server. The client identifies itself to the server using the client MAC address. The server, which maintains a pre-configured table of client device MAC addresses and associated IP addresses, sends the client its pre-configured IP address. BOOTP was originally used as a method that enabled diskless hosts to be remotely booted over a network. The BOOTP process assigns an infinite lease of an IP address. The BOOTP service utilizes UDP ports 67 and 68.

### **bps**

*(bit per second)* A definition of transmission rate, also given in conjunction with multiplier kilo (kbps) and mega (mbps).

### **bus base**

A mounting device that is designed to seat an electronic module on a DIN rail and connect it to the TM5 bus for M258 and LMC058 logic controllers. Each base bus extends the integrated TM5 data and electronic power buses as well as the 24 Vdc I/O power segment. The electronic modules are added to the TM5 system through their insertion on the base bus.

## C

### **calibration**

The process of setting or maintaining the accuracy of a measuring device by comparing its value to a known and correct standard.

### **CAN**

(*controller area network*) A protocol (ISO 11898) for serial bus networks, designed for the interconnection of smart devices (from multiple manufacturers) in smart systems and for real-time industrial applications. Originally developed for use in automobiles, CAN is now used in a variety of industrial automation control environments.

### **CANopen**

An open industry-standard communication protocol and device profile specification (EN 50325-4).

### **CFC**

(*continuous function chart*) A graphical programming language (an extension of the IEC 61131-3 standard) based on the function block diagram language that works like a flowchart. However, no networks are used and free positioning of graphic elements is possible, which allows feedback loops. For each block, the inputs are on the left and the outputs on the right. You can link the block outputs to the inputs of other blocks to create complex expressions.

### **CiA**

(*CAN in automation*) A non-profit group of manufacturers and users dedicated to developing and supporting CAN-based higher layer protocols.

### **continuous function chart language**

A graphical programming language (an extension of the IEC61131-3 standard) based on the function block diagram language that works like a flowchart. However, no networks are used and free positioning of graphic elements is possible, which allows feedback loops. For each block, the inputs are on the left and the outputs on the right. You can link the block outputs to inputs of other blocks to create complex expressions.

### **control network**

A network containing logic controllers, SCADA systems, PCs, HMI, switches, ...

Two kinds of topologies are supported:

- flat: all modules and devices in this network belong to same subnet.
- 2 levels: the network is split into an operation network and an inter-controller network.

These two networks can be physically independent, but are generally linked by a routing device.

### **controller**

Automates industrial processes (also known as programmable logic controller or programmable controller).

### **crosstalk**

An undesired signal caused by a capacitive, inductive, or conductive coupling between 2 channels.



**CSA**

(*Canadian standards association*) The Canadian standard for industrial electronic equipment in hazardous environments.

**CTS**

(*clear to send*) A data transmission signal and acknowledges the RDS signal from the transmitting station.

**cyclic task**

The cyclic scan time has a fixed duration (interval) specified by the user. If the current scan time is shorter than the cyclic scan time, the controller waits until the cyclic scan time has elapsed before starting a new scan.

**D****DHCP**

(*dynamic host configuration protocol*) An advanced extension of BOOTP. DHCP is more advanced, but both DHCP and BOOTP are common. (DHCP can handle BOOTP client requests.)

**digital I/O**

(*digital input/output*) An individual circuit connection at the electronic module that corresponds directly to a data table bit. The data table bit holds the value of the signal at the I/O circuit. It gives the control logic digital access to I/O values.

**DIN**

(*Deutsches Institut für Normung*) A German institution that sets engineering and dimensional standards.

**E****EN**

EN identifies one of many European standards maintained by CEN (*European Committee for Standardization*), CENELEC (*European Committee for Electrotechnical Standardization*), or ETSI (*European Telecommunications Standards Institute*).

**encoder**

A device for length or angular measurement (linear or rotary encoders).

**equipment**

A part of a machine including sub-assemblies such as conveyors, turntables, and so on.

**Ethernet**

A physical and data link layer technology for LANs, also known as IEEE 802.3.

## F

### FAST I/O

*FAST input/output* Specific I/O modules with some electrical features (for example, response time) while the treatment of these channels are done directly by the controller

### FBD

*(function block diagram)* One of 5 languages for logic or control supported by the standard IEC 61131-3 for control systems. Function block diagram is a graphically oriented programming language. It works with a list of networks, where each network contains a graphical structure of boxes and connection lines, which represents either a logical or arithmetic expression, the call of a function block, a jump, or a return instruction.

### FE

*(functional Earth)* A common grounding connection to enhance or otherwise allow normal operation of electrically sensitive equipment (also referred to as functional ground in North America).

In contrast to a protective Earth (protective ground), a functional earth connection serves a purpose other than shock protection, and may normally carry current. Examples of devices that use functional earth connections include surge suppressors and electromagnetic interference filters, certain antennas, and measurement instruments.

### firmware

Represents the BIOS, data parameters, and programming instructions that constitute the operating system on a controller. The firmware is stored in non-volatile memory within the controller.

### FTP

*(file transfer protocol)* A standard network protocol built on a client-server architecture to exchange and manipulate files over TCP/IP based networks regardless of their size.

### function

A programming unit that has 1 input and returns 1 immediate result. However, unlike FBs, it is directly called with its name (as opposed to through an instance), has no persistent state from one call to the next and can be used as an operand in other programming expressions.

Examples: boolean (AND) operators, calculations, conversions (BYTE\_TO\_INT)

### function block

A programming unit that has 1 or more inputs and returns 1 or more outputs. FBs are called through an instance (function block copy with dedicated name and variables) and each instance has a persistent state (outputs and internal variables) from 1 call to the other.

Examples: timers, counters

---

## H

**HMI**

*(human machine interface)* An operator interface (usually graphical) for human control over industrial equipment.

**HSC**

*(high-speed counter)* A function that counts pulses on the controller or on expansion module inputs.

## I

**I/O**

*(input/output)*

**IEC**

*(international electrotechnical commission)* A non-profit and non-governmental international standards organization that prepares and publishes international standards for electrical, electronic, and related technologies.

**IEC 61131-3**

Part 3 of a 3-part IEC standard for industrial automation equipment. IEC 61131-3 is concerned with controller programming languages and defines 2 graphical and 2 textual programming language standards. The graphical programming languages are ladder diagram and function block diagram. The textual programming languages include structured text and instruction list.

**input filter**

A special function that helps reject extraneous signals on input lines due to such things as contact bounce and inducted electrical transients. Inputs provide a level of input filtering using the hardware. Additional filtering with software is also configurable through the programing or the configuration software.

**IP**

*(Internet protocol)* Part of the TCP/IP protocol family that tracks the Internet addresses of devices, routes outgoing messages, and recognizes incoming messages.

**IP 20**

*(ingress protection)* The protection classification according to IEC 60529 offered by an enclosure, shown by the letter IP and 2 digits. The first digit indicates 2 factors: helping protect persons and for equipment. The second digit indicates helping protect against water. IP 20 devices help protect against electric contact of objects larger than 12.5 mm, but not against water.

**IP 67**

*(ingress protection)* The protection classification according to IEC 60529. IP 67 modules are protected against ingress of dust, contact, and water up to an immersion depth of 1 m.

## L

### LED

(*light emitting diode*) An indicator that illuminates under a low-level electrical charge.

## M

### machine

Consists of several *functions* and/or *equipment*.

### MAST

A processor task that is run through its programming software. The MAST task has 2 sections:

- **IN:** Inputs are copied to the IN section before execution of the MAST task.
- **OUT:** Outputs are copied to the OUT section after execution of the MAST task.

### Modbus

The protocol that allows communications between many devices connected to the same network.

### ms

(*millisecond*)

## N

### NC

(*not connected*)

### network

A system of interconnected devices that share a common data path and protocol for communications.

### node

An addressable device on a communication network.

## P

### PCI

(*peripheral component interconnect*) An industry-standard bus for attaching peripherals.

### PDM

(*power distribution module*) A module that distributes either AC or DC field power to a cluster of I/O modules.

**PE**

(*Protective Earth*) A common grounding connection to help avoid the hazard of electric shock by keeping any exposed conductive surface of a device at earth potential. To avoid possible voltage drop, no current is allowed to flow in this conductor (also referred to as *protective ground* in North America or as an equipment grounding conductor in the US national electrical code).

**Profibus DP**

(*Profibus decentralized peripheral*) An open bus system uses an electrical network based on a shielded 2-wire line or an optical network based on a fiber-optic cable. DP transmission allows for high-speed, cyclic exchange of data between the controller CPU and the distributed I/O devices.

**protocol**

A convention or standard definition that controls or enables the connection, communication, and data transfer between 2 computing system and devices.

**PWM**

(*pulse width modulation*) A fast output that oscillates between off and on in an adjustable duty cycle, producing a rectangular wave form (though you can adjust it to produce a square wave).

**R****reflex output**

Among the outputs of HSC are the reflex outputs associated to a threshold value that is compared to the counter value depending on the configuration of the HSC. The reflex outputs switch to either on or off depending on the configured relationship with the threshold.

**RTC**

(*real-time clock*) A battery-backed time-of-day and calendar clock that operates continuously, even when the controller is not powered for the life of the battery.

**RTS**

(*request to send*) A data transmission signal and CTS signal that acknowledges the RTS from the destination node.

**RTU**

(*remote terminal unit*) A device that interfaces with objects in the physical world to a distributed control system or SCADA system by transmitting telemetry data to the system and/or altering the state of connected objects based on control messages received from the system.

**run**

A command that causes the controller to scan the application program, read the physical inputs, and write to the physical outputs according to solution of the logic of the program.

**RxD**

The line that receives data from one source to another.

## S

### scan

A function that includes:

- reading inputs and placing the values in memory
- executing the application program 1 instruction at a time and storing the results in memory
- using the results to update outputs

### SFC

(*sequential function chart*) A language that is composed of steps with associated actions, transitions with associated logic condition, and directed links between steps and transitions. (The SFC standard is defined in IEC 848. It is IEC 61131-3 compliant.)

### sink input

A wiring arrangement in which the device provides current to the input electronic module. A sink input is referenced to 0 Vdc.

### SNMP

(*simple network management protocol*) A protocol that can control a network remotely by polling the devices for their status and viewing information related to data transmission. You can also use it to manage software and databases remotely. The protocol also permits active management tasks, such as modifying and applying a new configuration.

### source output

A wiring arrangement in which the output electronic module provides current to the device. A source output is referenced to +24 Vdc.

### ST

(*structured text*) A language that includes complex statements and nested instructions (such as iteration loops, conditional executions, or functions). ST is compliant with IEC 61131-3.

## T

### task

A group of sections and subroutines, executed cyclically or periodically for the MAST task or periodically for the FAST task.

A task possesses a level of priority and is linked to inputs and outputs of the controller. These I/O are refreshed in relation to the task.

A controller can have several tasks.

### terminal block

(*terminal block*) The component that mounts in an electronic module and provides electrical connections between the controller and the field devices.

### TxD

The line that sends data from one source to another.

## U

### UL

(*underwriters laboratories*) A US organization for product testing and safety certification.







## A

Analog AI4LE, *139*

## C

CAN Port, *96*

Communication Ports, *91*

## D

Digital DI12DE, *130*

Digital DI6DE, *126*

Digital DO12TE, *134*

## E

environmental characteristics, *23*

Ethernet Port, *92*

Expert I/O, *112*

## F

Fast Inputs Characteristics, *117*

Fast Outputs, *122*

First Startup, *39*

## I

installation and Maintenance

    installation and Maintenance require-  
    ments, *14*

intended use, *6*

## M

M258

    TM258LD42DT, *41*

    TM258LD42DT4L, *49*

    TM258LF42DR, *81*

    TM258LF42DT, *57*

    TM258LF42DT4L, *65*

    TM258LF66DT4L, *73*

## P

PCI Slots, *109*

Pin Assignment

    CAN Port (CAN 0 or CAN 1), *98*

    Serial Line Port, *106*

## Q

qualification of personnel, *6*

## S

Serial Line Port, *104*

Startup procedure

    First Startup, *39*

Status LED

    Serial Line Port, *107*

    USB Host Port, *103*

Status LEDs

    CAN Ports, *99*

    Ethernet Port, *94*

## T

TM258LD42DT, *41*

TM258LD42DT4L, *49*

TM258LF42DR, *81*

TM258LF42DT, *57*

TM258LF42DT4L, *65*

TM258LF66DT4L, *73*

## U

USB Host Port, *102*

USB Programming Port, *100*

## W

wiring rules, *17*